



OPERATING AND SERVICE INSTRUCTIONS

---

**RADIO RECEIVER  
MODEL SX-62B**

## WARRANTY

*"The Hallicrafter's Company warrants each new radio product manufactured by it to be free from defective material and workmanship and agrees to remedy any such defect or to furnish a new part in exchange for any part of any unit of its manufacture which under normal installation, use and service discloses such defect, provided the unit is delivered by the owner to our authorized radio dealer, wholesaler, from whom purchased, or, authorized service center, intact, for examination, with all transportation charges prepaid within ninety days from the date of sale to original purchaser and provided that such examination discloses in our judgment that it is thus defective.*

*This warranty does not extend to any of our radio products which have been subjected to misuse, neglect, accident, incorrect wiring not our own, improper installation, or to use in violation of instructions furnished by us, nor extended to units which have been repaired or altered outside of our factory or authorized service center, nor to cases where the serial number thereof has been removed, defaced or changed, nor to accessories used therewith not of our own manufacture.*

*Any part of a unit approved for remedy or exchange hereunder will be remedied or exchanged by the authorized radio dealer or wholesaler without charge to the owner.*

*This warranty is in lieu of all other warranties expressed or implied and no representative or person is authorized to assume for us any other liability in connection with the sale of our radio products."*

*the hallicrafters* CO.

092-04555

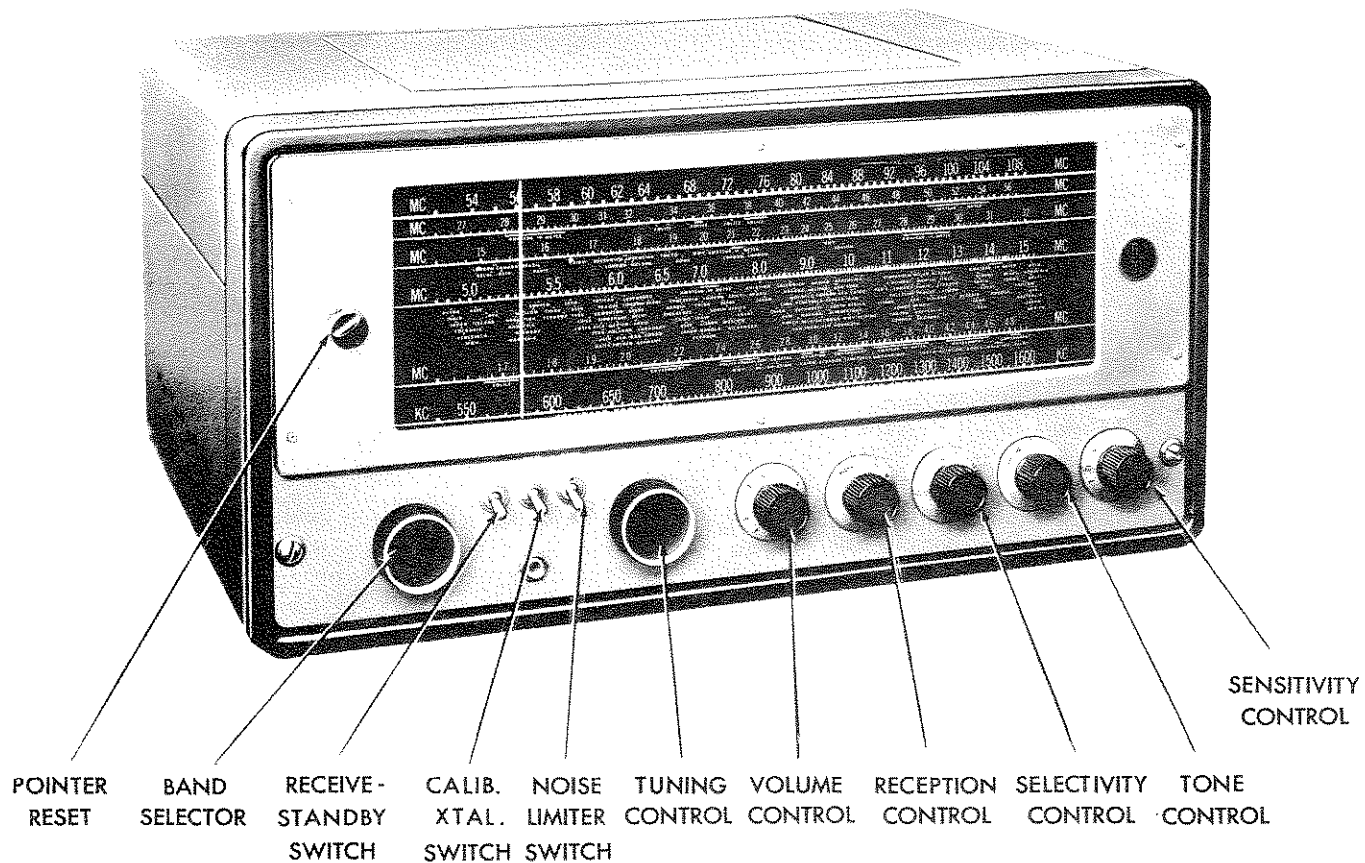

Figure 1. Radio Receiver Model SX-62B/62BU

92X519-A

## GENERAL SPECIFICATIONS

Tubes . . . . .	Thirteen plus voltage regulator and rectifier
Speaker Output. . . . .	500/5000 ohms
Headset Output. . . . .	High impedance
Antenna Input. . . . .	For 50 to 600 ohm line or single wire lead-in
Phono Input . . . . .	High impedance
External Power Connector . .	Std. octal socket
Tuning Range. . . . .	See Frequency Coverage
Intermediate Frequency. . . .	455 kc/10.7 mc
Power Supply. . . . .	SX-62B 105-125V 60 Cycles AC SX-62BU 105-250V 25/100 Cycles AC
Power Consumption . . . . .	120 Watts

## FREQUENCY COVERAGE

BAND	FREQUENCY RANGE	TYPE OF RECEPTION
1	550 KC - 1620 KC	AM/CW
2	1.62 MC - 4.9 MC	AM/CW
3	4.9 MC - 15 MC	AM/CW
4	15 MC - 32 MC	AM/CW
5	27 MC - 56 MC	AM/FM/CW
6	54 MC - 109 MC	AM/FM/CW

The Model SX-62B (SX-62BU, available on special order) receiver is a sensitive high fidelity superheterodyne receiver covering all of the broadcasting services between 540 kilocycles (KC) and 109 megacycles (MC). The receiver is capable of receiving both the FM (Frequency Modulation) and AM (Amplitude Modulation) broadcasts transmitted in this frequency range as shown in the FREQUENCY COVERAGE chart.

A built-in 500 kc crystal controlled calibrating oscillator and adjustable dial pointer permit accurate dial calibration on the large direct reading slide rule dial. Marker signals appear every 500 kc on the dial scale with this type of marker oscillator; hence, dial calibration may be held to very close limits over the entire dial scale by comparison with the marker signal.

This calibration feature of the Model SX-62 receiver makes it possible to log the most prominent shortwave stations by countries directly on the dial. In addition, many of the active communication channels; government, amateur, police, aviation, etc. are logged by bars to indicate their location on the dial. World-wide reception is accomplished simply by selecting the desired frequency band (band selector switch) and adjusting the tuning control so that the pointer is above the station locating dot.

The receiver selectivity is adjustable to accommodate the broad response required for high fidelity FM and AM broadcast reception to the sharpest crystal selectivity required for code reception in the crowded channels of the short wave bands. A FM-AFC position on the RECEPTION switch "locks" the receiver onto the station frequency.

The high fidelity tone compensated audio system provides four distinct tone ranges covering full range reception for entertainment purposes as well as the restricted range required for communication work in either voice or code.

An automatic noise limiter, operated by a toggle switch, permits the operator to reduce the background noise caused by severe electrical disturbances. Background noise is reduced in the model SX-62 with a minimum of audio distortion.

A RECEIVE-STANDBY switch permits receiver disabling for short standby periods without having to wait for the tube heaters to reach operation temperature when reception is again required.

The receiver normally operates from a 105-125 volt 60 cycle alternating current (AC) source. A connector for operating the receiver with external batteries or equivalent power is provided to permit operation in areas where AC current does not exist. A special model of the SX-62B receiver permits operation from 25/100 cycle alternating current sources operating at voltages ranging from 105-250 volts. The power requirements for your receiver must be checked carefully. Read over the installation section of this book before connecting to your power source.

### IMPORTANT

Your careful attention is especially invited to the installation and operating instructions. They have been provided to insure the satisfaction you have a right to expect from a Hallicrafters "Precision Built" product. Your receiver has an unusually high degree of sensitivity necessary to receive weak and distant stations. Careless operation of a high sensitivity receiver may result in excess noise or background hiss. These undesirable effects can be held to a minimum by careful adjustment of the sensitivity, tuning and tone controls as well as proper selection and arrangement of the antenna.

## INSTALLATION

**UNPACKING** - Check all shipping instruction tags carefully before removing them.

**LOCATION** - The receiver is equipped with rubber feet for table top or shelf mounting. When locating the receiver, avoid excessively warm locations such as near radiators, hot air registers, or confined dead air spaces such as are encountered in recessed installations.

**POWER SOURCE** - The receiver, as normally supplied, operates from a 105 to 125 volt, 50/60 cycle AC outlet. Power consumption is approximately 120 watts. If you are in doubt or unfamiliar with the voltage and frequency rating of your utility service, consult your local power company representative. Attempting to operate the receiver from other sources of power than specified may involve costly repairs.

A special model is available for operation from 115 V./130 V./150 V./220 V./250 V. 25/100 cycle AC sources. A selector switch on the power transformer permits operation on any of the line voltages shown.

**CAUTION** - When operating the universal model, it is necessary to check, and set if necessary, the selector switch on the power transformer before connecting the receiver to the source of power.

**SPEAKER CONNECTION** - Three screw type terminals, located on the rear chassis apron, are provided for the speaker connection. The output impedances available are 500 and 5000 ohms. Any suitable speaker unit which will operate with either of these output impedances may be used with the Model SX-62B receiver. Hallicrafters Model PM-23 speaker connects to the 5000-ohm terminals (marked "COM/5000"); the Model R-42 and R-44 speaker units connect to the 500-ohm terminals (marked "COM/500").

ERRATA SHEET  
MODEL SX-62B

The following changes are to be incorporated in the MODEL SX-62B Operating and Service Instructions Manual.

Page 3 - GENERAL SPECIFICATIONS. Change:

Speaker Output to 3.2/8/500 ohms  
External Power Connector not applicable to SX-62B

Page 4 - Delete second sentence of sixth paragraph.

Page 4 - INSTALLATION. Change SPEAKER CONNECTION paragraph to read as follows:

Four screw type terminals located on the rear chassis apron, are provided for the speaker connection. The output impedances are 3.2, 8, and 500 ohms. Any suitable speaker unit which will operate with the available output impedances may be used with the Model SX-62B receiver. Hallicrafters Model R-48A speaker connects to the 3.2 ohm terminals (marked COM/3.2).

Page 5 - Figure 2. Change:

Speaker Connections to 3.2 - 8 - 500

Page 7 - Change MULTIPLEX OUTPUT paragraph to read as follows:

A jack, located on the rear panel, provides an output from the FM detector that may be used with a multiplex adapter and stereo system for reception of stereo broadcasts in the FM band.

Page 8 - Figure 5. Change 6H6 to 6AL5.

Page 13 - Figure 13. Change V9, 6H6, to 6AL5.

Form Number 094-903967  
Pack with Instruction Manual  
094-903945

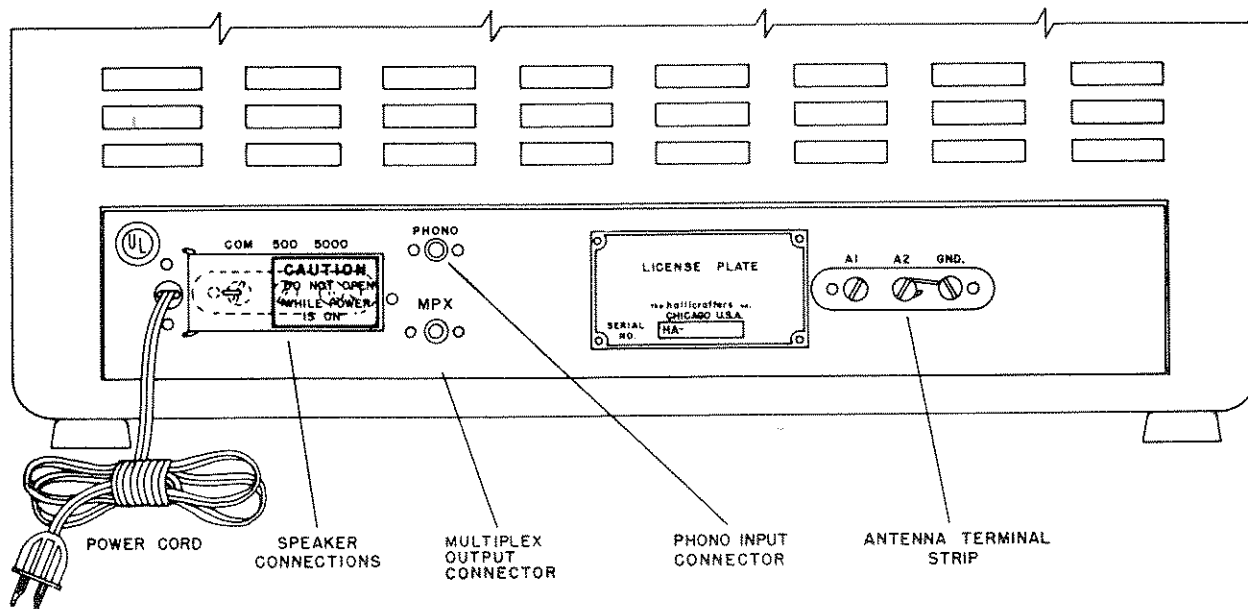

920521

Figure 2. Rear View

**ANTENNA** - The terminals marked A1, A2, and G on the back of the receiver are for the antenna and ground connections. Satisfactory results can be obtained in most localities with the 15 foot antenna wire included with your receiver. Simply uncoil this wire, connect one end of it to terminal A1, and then connect the jumper between terminals A2 and G. An outside antenna 50 to 100 feet long (ordinary copper wire) may be necessary if the receiver is located in a difficult reception area or steel constructed building. In some locations, reception may be improved by connecting a lead from terminal G to a cold water pipe or outside ground rod.

**Doublet Antenna** - For really top performance, there is no substitute for an outside doublet antenna. When properly constructed and installed, the doublet antenna will provide not only optimum shortwave reception but excellent standard broadcast reception as well. The overall length (in feet) of the doublet is determined by dividing 468 by the frequency (in megacycles) at the high end of the range to which you wish to listen. A doublet antenna is directional broadside to its length and should be so oriented with respect to a desired station for maximum signal pickup.

By feeding the doublet antenna with a 300 ohm transmission line, a broader frequency response is obtained than that possible with a 50-75 ohm line. If a ribbon type transmission line is used, connect the line to terminals A1 and A2 and disconnect the jumper between A2 and G. When using a coaxial transmission line, connect the inner conductor to A1, the outer conductor to A2, and place the jumper between A2 and G.

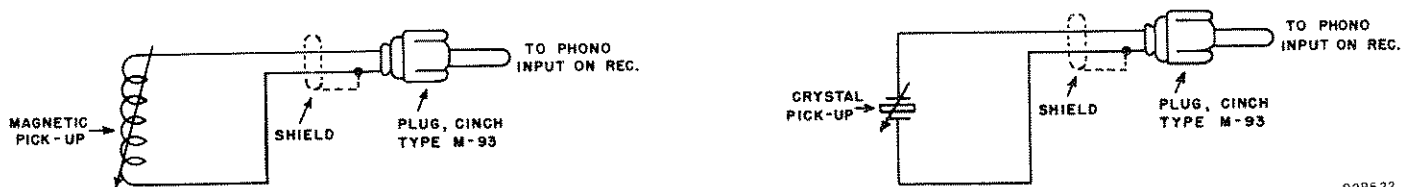

928522

Figure 3. Wiring Diagram, Record Player Connection.

**RECORD PLAYER CONNECTION** - A shielded type receptacle is provided at the rear chassis apron to accommodate a record player pickup cable connector. Any record player employing a crystal cartridge or high level magnetic pickup in its tone arm may be used with the receiver. Refer to Figure 3. for wiring details.

# OPERATION

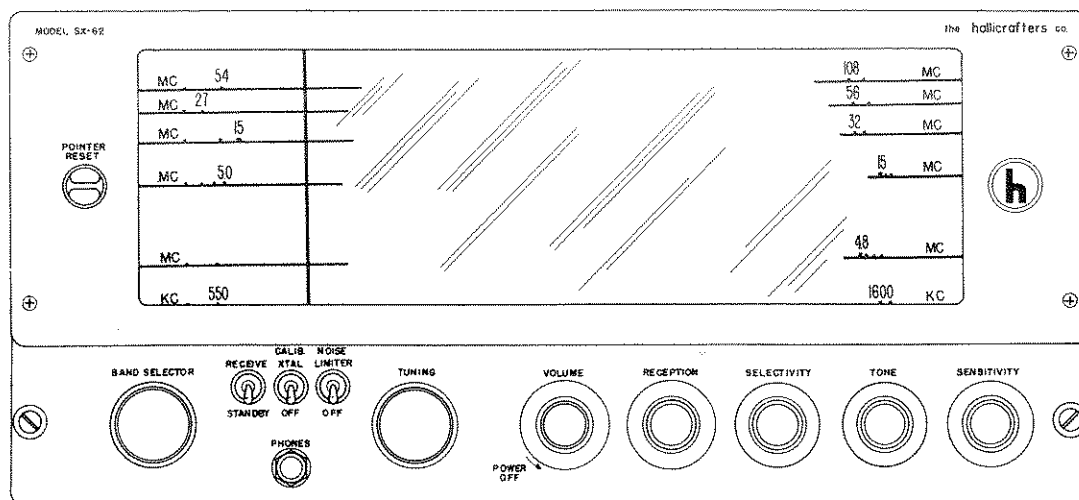

Figure 4. Front View, Location of Controls.

92C523-A

**GENERAL BROADCAST RECEPTION** - Certain front panel controls have been color coded to simplify the tuning procedure for general entertainment purposes. High fidelity reception in the standard broadcast (AM) and frequency modulation (FM) bands may be accomplished as follows: Turn the volume control clockwise beyond the tell tale click of the switch. This turns the receiver on as indicated by the illumination of one of the dial scales. Similarly the receiver is turned off by turning the control counter-clockwise beyond the click of the switch. At this point the three "bat-handle" switches may be set at "RECEIVE" and "OFF" and forgotten. To receive standard broadcast (AM) services; set the BAND SELECTOR for the position that illuminates the 550-1620 kilocycle scale (bottom scale), set the RECEPTION, SELECTIVITY, TONE and SENSITIVITY controls per the red dot, and adjust the TUNING and VOLUME controls in the normal manner, tuning for clearest reception as usual.

## OPERATION FOR RADIO TELEPHONE AND CW

### CONTROL

### RADIO-TELEPHONE

### CW

VOLUME control -	This control turns the receiver on and off in addition to controlling the volume. Turn the control clockwise to turn on the receiver or increase volume, and counter-clockwise to reduce volume or turn off the receiver.	Same
RECEIVE/STANDBY switch -	Normally set at "RECEIVE". May be set at "STANDBY" to disable the receiver for short standby periods and yet keep the tube heaters at operating temperature for instant use.	Same
RECEPTION control -	Set at "AM" for reception of amplitude modulated stations located in the standard broadcast band or any of the shortwave bands, or at "FM" to tune FM stations located in the two highest frequency ranges (two top dial scales), then set at "FM-AFC" to lock onto the station frequency.	Set at "CW"
BAND SELECTOR -	Set for position that illuminates the dial scale covering the desired band of frequencies. Extreme left hand position of this control illuminates the lowest dial scale.	Same
TUNING control -	The tuning control sets the frequency of reception, tuning the band of frequencies shown on the illuminated dial scale. The frequency of reception is shown in kilocycles (KC) on the standard broadcast range and in megacycles (MC) on the shortwave and FM ranges. The frequencies of the local stations are generally listed in newspapers, AM stations in kilocycles and FM stations in megacycles. Information on short wave stations, not identified directly from the dial, may be obtained from published log books available at most book stores or radio supply houses. When tuning for the station, tune carefully for the clearest reception and obtain top performance from your receiver.	The tuning control sets the frequency of reception, tuning the band of frequencies shown on the illuminated dial scale. The frequency of reception is shown in megacycles (MC) on the shortwave bands used by code transmitters. When tuning for the station, tune for the pitch of the code signal found easiest to copy. The pitch of the code signal will usually run approximately 1000 cycles.

SELECTIVITY  
control -

Normally set at "NORMAL/BROAD" for high fidelity reception in the standard broadcast and FM bands. Use the "NORMAL/MED." or "NORMAL/SHARP" for the more crowded conditions existing in most of the short-wave ranges. Note that as the receiver is made more selective, the background noise and interference from nearby stations is reduced. The setting of the selectivity control is generally best determined by receiving conditions, using just enough selectivity to isolate the desired stations. The "CRYSTAL/BROAD" position may be used when the frequency of reception is extremely congested.

This control may be set at "NORMAL/MED." OR "NORMAL/SHARP" for the reception of code stations not suffering local interference. Congested receiving conditions may be handled by increasing selectivity, switching to one of the three crystal positions for the degree of selectivity required. Note that in the crystal position the tuning of the receiver changes, i.e. the desired station will be very loud on one side of zero beat and very weak (crystal slot) on the other side.

SENSITIVITY  
control -

Normally set maximum clockwise. Local high powered stations may overload the receiver, showing up as distortion, hence conditions may require that this control be turned counter-clockwise to reduce the sensitivity of the receiver accordingly.

The receiver sensitivity must be controlled manually for code reception, hence the SENSITIVITY control must be advanced just enough to keep the code stations from blocking the receiver.

## TONE control -

Normally set at "HI-FI" or "BASS" for AM or FM entertainment purposes. The "LOW" and "MED." positions will be found desirable when listening on the shortwave bands.

Normally set at "LOW" or "MED." for code reception.

**USE OF THE CALIBRATING CRYSTAL** - A built-in secondary frequency standard and adjustable dial pointer permits accurate frequency calibration over any portion of the receiver dial. Three degrees of dial calibration accuracy may be had as follows:

1. General Dial Indexing - Run the dial pointer down to the left hand end of the dial scale, turning the TUNING knob until the left hand dial stop is reached. Line up the dial pointer with the index line using the small POINTER RESET knob located to the left of the dial escutcheon.
2. Average Dial Calibration - Index the dial pointer as described above. Set the CALIB. XTAL switch at "CALIB. XTAL", RECEPTION switch at CW, and tune the receiver to zero beat with the calibrating oscillator signal, i.e. the pitch of the whistle or beat note will pass through zero cycles at the exact center of the marker signal. The oscillator signals will be found at multiples of 500 kilocycles on the lower 5 dial scales, i.e. 1000 kc and 1500 kc; 2 mc, 2.5 mc, 3 mc etc.; 5 mc, 5.5 mc, 6 mc, etc.; 15 mc, 15.5 mc, 16 mc, etc.; or 27 mc, 27.5 mc, 28 mc, etc. After setting the TUNING control for zero beat, center the dial pointer exactly on the half-mega-cycle dial division. For best results, the receiver sensitivity must be held to a minimum while making calibration adjustments.
3. Precise Dial Calibration - To obtain a precise dial calibration the procedure outlined above should be repeated for the particular section of the dial in use rather than merely checking calibration at either end of the dial scale. Since the calibration signals appear every 500 kc along the dial, a calibration point may easily be obtained on either side of the frequency of reception at any point along the dial.

After calibrating the receiver dial with the calibrating crystal, the oscillator is switched OFF and the RECEPTION switch returned to the desired setting for normal reception.

**RECORD PLAYER OPERATION** - With a record player connected to the receiver it is merely necessary to set the RECEPTION control at PHONO and operate the VOLUME and TONE controls as for normal radio reception.

**CAUTION** - The receiver will not respond if the RECEIVE/STANDBY switch is set at "STANDBY". The setting of the remaining controls, except those mentioned above, is immaterial as they are not in use for record player operation.

**MULTIPLEX OUTPUT** - A jack, located at the rear panel, permits operation into any standard high fidelity system.



HEADPHONE RECEPTION - A headset jack, located at the front panel, provides for headphone reception. Insertion of the headset plug disables the speaker. Any high impedance headset, magnetic or crystal, will work with the receiver.

## SERVICE

TUBE REPLACEMENT - The types of tubes required and their relative position in the receiver are shown in the illustration, Fig. 5. When installing a replacement tube, insert the center guide pin into the center hole of the tube socket; rotate the tube until the key on the guide pin drops into the notch in the socket hole; and push down until the base of the tube rests firmly on the socket. A slightly different technique must be used on the miniature tubes. They have seven small pins which have to be lined up with the socket holes before pushing into place. Handle with care as all tubes are considered fragile and do not tolerate much mechanical abuse.

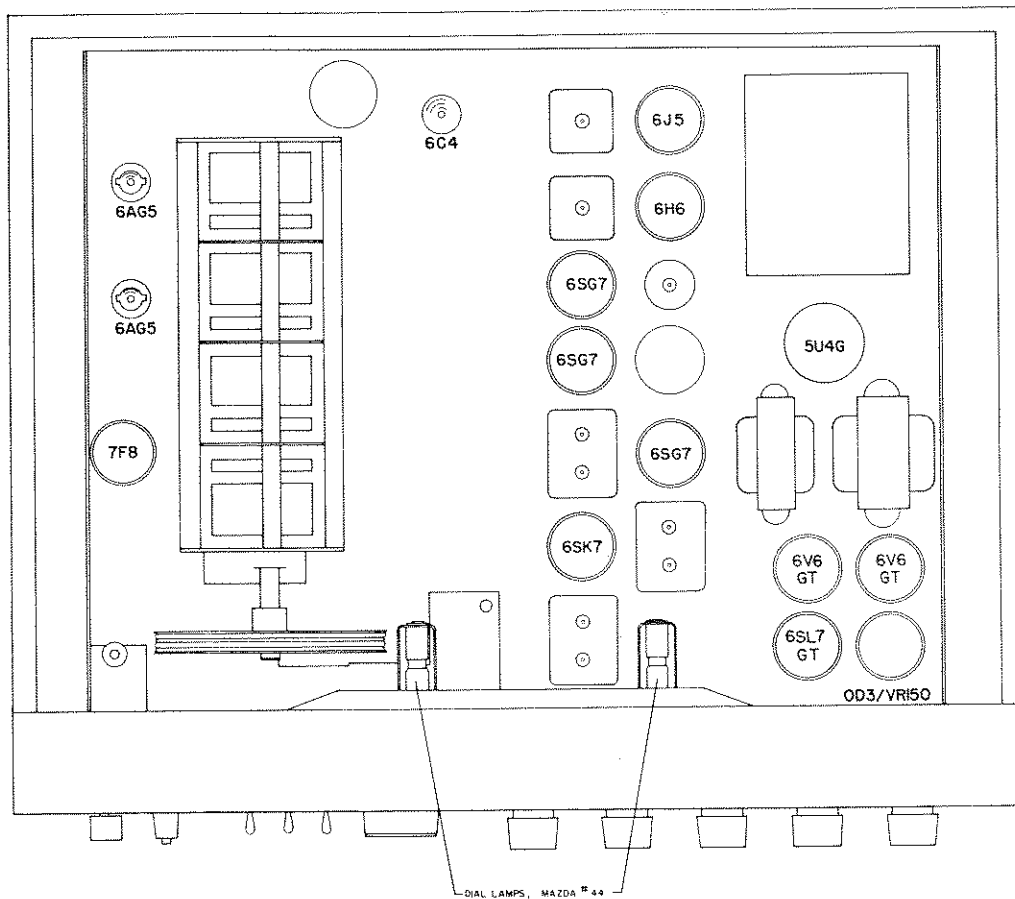

920524-A

Figure 5. Top View Showing Location of Tubes and Dial Lamps

DIAL LAMP REPLACEMENT - Refer to Fig. 5 for the location of the dial lamps used in the receiver. To gain access to defective lamps, open the cabinet cover, remove the light shield (four screws) and unclip the dial lamp socket by compressing the side springs. The socket may then be brought out into the open to change the defective lamps. Replace all lamps with 6-8 volt Mazda No. 44 (blue bead) or equivalent.

SERVICE OR OPERATING QUESTIONS - For further details regarding operation or servicing of the receiver, contact your dealer. Make no service shipments directly to the factory before first writing for authorization and instructions.

*The factory cannot accept responsibility for unauthorized shipments.*

The Hallicrafters Co. reserves the privilege of making revisions in current production of equipment and assumes no obligation to incorporate these revisions in earlier models.

## POSITIONING CONTROL KNOBS

BAND SELECTOR . . . As required by flat on shaft  
 VOLUME . . . . . Set at 10 for full clockwise rotation  
 RECEPTION . . . . . As required by markings

SELECTIVITY . . . As required by markings  
 TONE . . . . . As required by markings  
 SENSITIVITY . . . Set at 10 for full clockwise rotation

## RESTRINGING DIAL CORD

Restring the tuning capacitor drive with a 45 inch length of 30 lb. test dial cord. Tie one end of the cord to the tension spring at position A and follow the stringing sequence A through J as shown. At position J stretch the tension spring and tie the cord securely to the spring. Note that the dial cord is wrapped around the tuning drive shaft two and three-quarters times for proper traction.

Restring the dial pointer drive with a 75 inch length of 30 lb. test dial cord. Tie one end of the cord to the tension spring at position 1 and follow the stringing sequence 1 through 12 as illustrated. At position 12 stretch the tension spring and tie the cord securely.

Index the dial pointer by setting the tuning gang at maximum capacity, the RESET control in the middle of its range, and aligning the pointer with the left hand dial index marker.

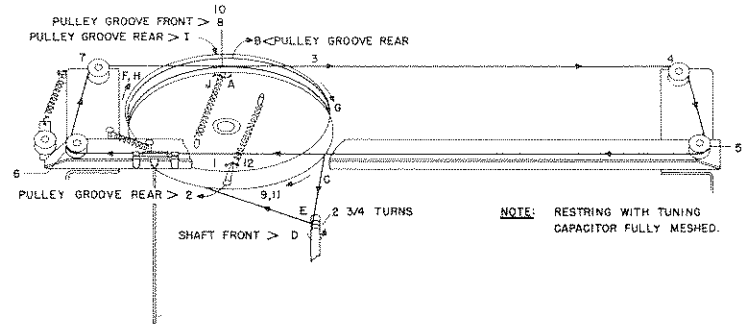

Figure 6. Dial Cable Stringing Procedure

## ALIGNMENT PROCEDURE

IF AMP ALIGNMENT (455 kc) - Set the controls as follows:

BAND SELECTOR . . . . .	550/1620 kc range	RECEPTION control . . . . .	AM
RECEIVE/STANDBY switch. .	RECEIVE	SELECTIVITY control . . . . .	NORMAL/SHARP
CALIB. XTAL switch . . . . .	OFF	SENSITIVITY control . . . . .	Near Maximum
NOISE LIMITER switch. . . . .	OFF	Set tuning dial pointer at approximately 1,000 kc.	
VOLUME control . . . . .	Near Maximum		

Connect high side of signal generator through an 0.1 mfd. capacitor to pin #1, of the 7F8 converter tube. With signal generator set at approximately 455 kc align slugs S-1, 3, 5, 10, 12 and 14 for maximum output.

Set RECEPTION control at CW and adjust slug S-8 for a 1,000 cycle note.

Set the SELECTIVITY control at CRYSTAL/BROAD. While slowly turning slug S-10 in one direction across the resonant setting obtained above, "rock" the signal generator tuning and observe the dip in the output meter reading as the adjustment passes through the response of the crystal filter. The correct setting of the slug S-10 is in the center of the observed dip. Set the signal generator at the weaker of the two responses obtained on either side of zero beat and adjust the crystal phasing trimmer C-57 for the null.

Set the SELECTIVITY control at CRYSTAL/SHARP and with trimmer C-61 set near minimum capacity, slowly increase its capacity while "rocking" the signal generator and adjust for maximum output. It may be necessary at this point to reduce the signal generator input and the receiver sensitivity to prevent overloading. After peaking the adjustment turn the trimmer in until a drop in output of about 2 db occurs. At this point the sharp crystal will have very good selectivity without sacrificing too much gain.

Tune the signal generator to exact crystal frequency and note output meter reading. Set the SELECTIVITY control at CRYSTAL/BROAD and note the drop in output, and output meter reading. Now switch to CRYSTAL/MEDIUM and with trimmer C-60 near minimum capacity, slowly increase its capacity, while "rocking" the signal generator, until the output meter indicates about midway between the output readings obtained in sharp crystal and broad crystal position.

Set the SELECTIVITY control at CRYSTAL/SHARP and reset signal generator for the exact crystal frequency. Switch to NORMAL/SHARP and reset slugs S-1,3,5 12,14 and trimmer C-58 for maximum output.

Set the RECEPTION control at CW and adjust the BFO slug S-8 for zero beat.

IF AMP. ALIGNMENT (10.7 mc) - Set the controls as follows:

BAND SELECTOR . . . . .	27/56 mc range	RECEPTION control . . . . .	AM
RECEIVE/STANDBY switch. .	RECEIVE	SELECTIVITY control . . . . .	NORMAL/SHARP
CALIB. XTAL switch . . . . .	OFF	SENSITIVITY control . . . . .	Near Maximum
NOISE LIMITER switch. . . . .	OFF	Set tuning dial pointer at approx. midscale.	
VOLUME . . . . .	Near Maximum		

Connect the high side of the signal generator through an 0.1 mfd. capacitor to pin #1 of the 7F8 converter tube. Set signal generator at 10.7 mc and adjust slugs S-4,6,9,13 and 15 for maximum output. Now set slugs S-2 and S-11 for maximum output but do not readjust slugs S-4 6,9, 13 and 15.

Set RECEPTION control at CW and adjust slugs S-17 for zero beat.

Set RECEPTION control at FM and adjust slug S-16 for maximum output. Now set Slug S-7 for the null or minimum output as indicated on the output meter. Check the discriminator by slowly tuning the signal generator through 10.7 mc and observe the two maximum audio level readings on the output meter. If the two peaks are equal the job is done; if not it may be necessary to reset Slug S-16 until a reasonable balance is obtained.

## RF AMP ALIGNMENT

After completing the alignment of the IF amplifier stages the RF amplifier stages may be aligned according to the following chart. Connect the high side of the signal generator to terminal A-1 through the dummy antenna specified and connect a jumper between antenna terminal A-2 and GND. Use just enough signal generator output to obtain a 500 milliwatt audio output level for best results.

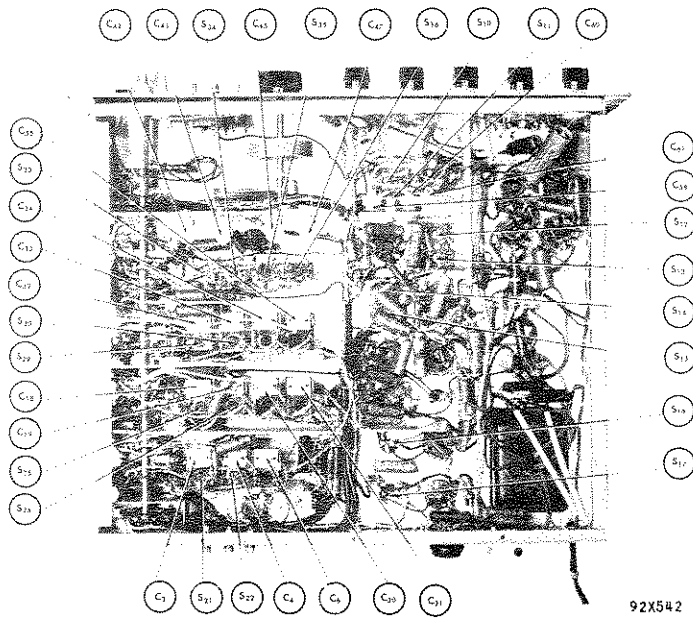

Figure 7. Alignment Adjustments, Bottom View

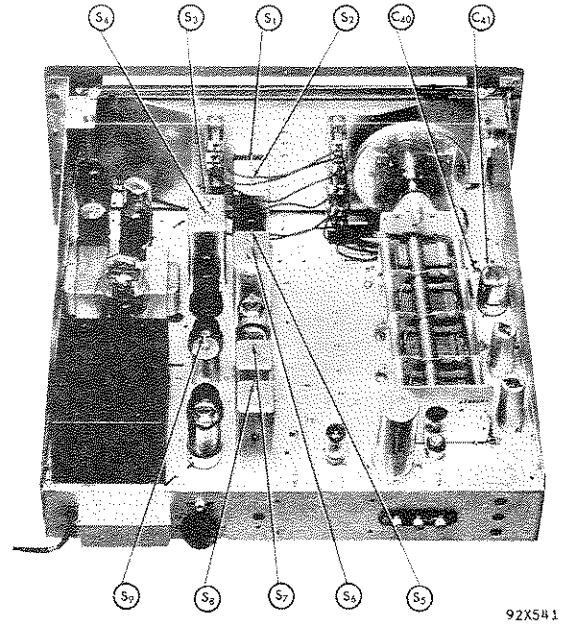

Figure 8. Alignment Adjustments, Top View

### ALIGNMENT CHART

Dummy Antenna	Signal Generator Frequency	Band Selector Range	Radio Dial Setting	Adjust	Remarks
RMA	1500 kc	550-1600 kc	1500 kc	C-47*, 6, 21, 35	Adjust for max. output
	600 kc		600 kc	S-36*	
RMA	4.5 mc	1.62-4.9 mc	4.5 mc	C-45*, 20, 34	Adjust for max. output
	2.0 mc		2.0 mc	S-35*	
RMA	14.0 mc	4.9-15 mc	14.0 mc	C-43*, 4, 19, 33	Adjust for max. output
	7.0 mc		7.0 mc	S-34*, 22, 26, 30	
RMA	28 mc	15-32 mc	28 mc	C-42*, 3, 18, 32	Adjust for max. output
	18 mc		18 mc	S-33*, 21, 25, 29	
300-ohm non-inductive resistor	50 mc	27-56 mc	50 mc	C-41*, 2, 17, 31	Adjust for max. output
	30 mc		30 mc	S-32*, 20, 24, 28	
300-ohm non-inductive resistor	105 mc	54-109 mc	105 mc	C-40*, 1, 16, 30	Adjust for max. output
	60 mc		60 mc	S-31*, 19, 23, 27	

\* Note - Calibration adjustment.

Note - The standard RMA dummy antenna mentioned in the alignment chart consists of a 200 mmf condenser in series with a 20 uh r-f choke which is shunted by a 400 mmf condenser in series with a 400 ohm carbon resistor.

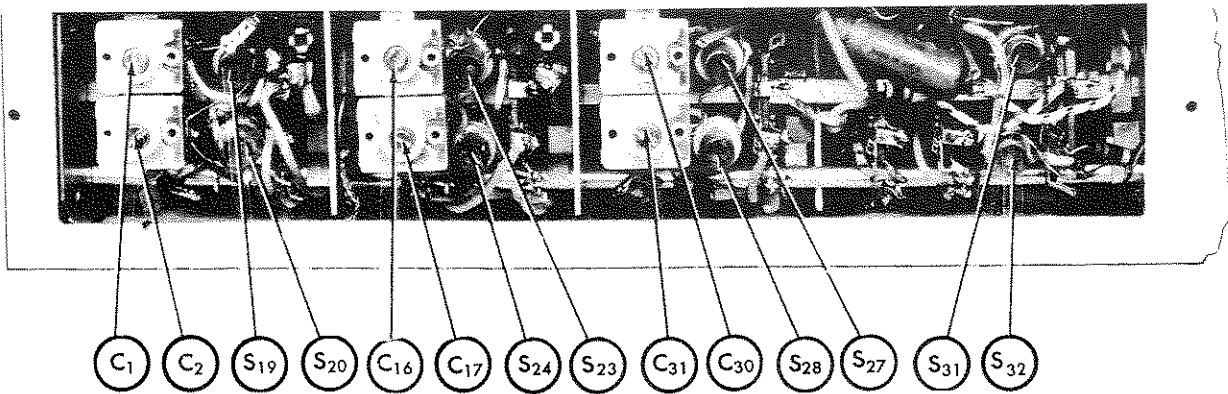

Figure 9. Alignment Adjustments, Left Side View

92X543

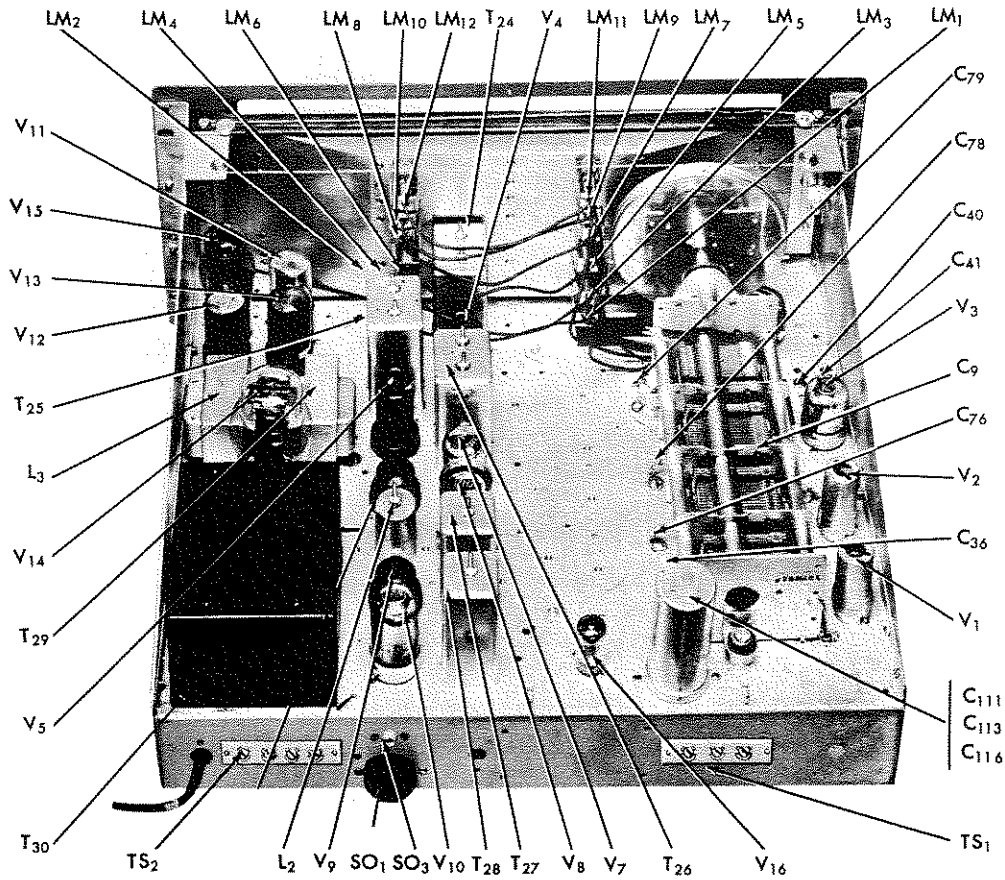

Figure 10. Component Locations, Top View

92X544-A

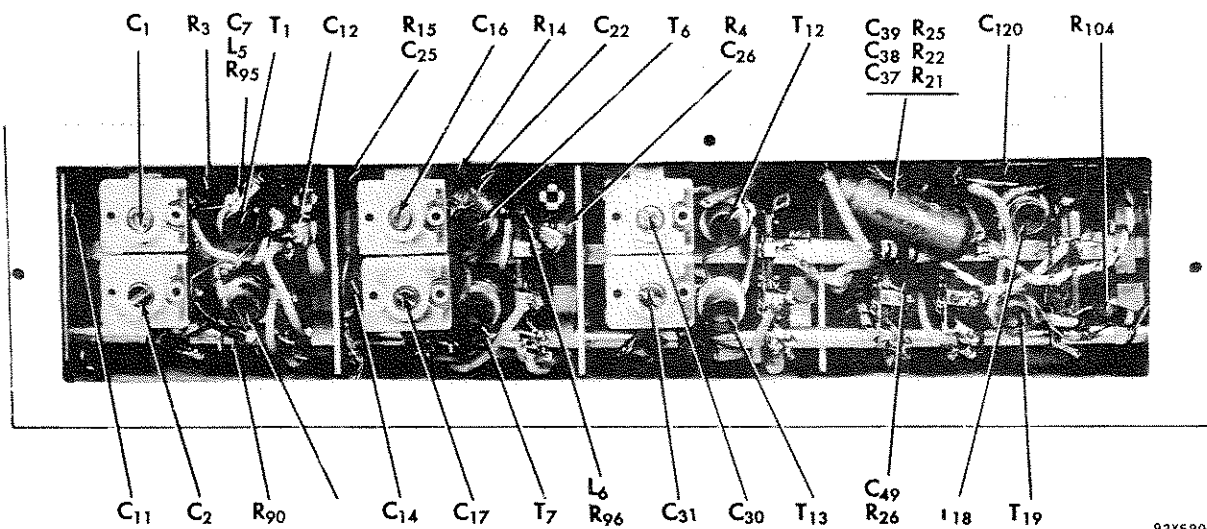

Figure 11. Component Locations, Left Side View

92X580-A

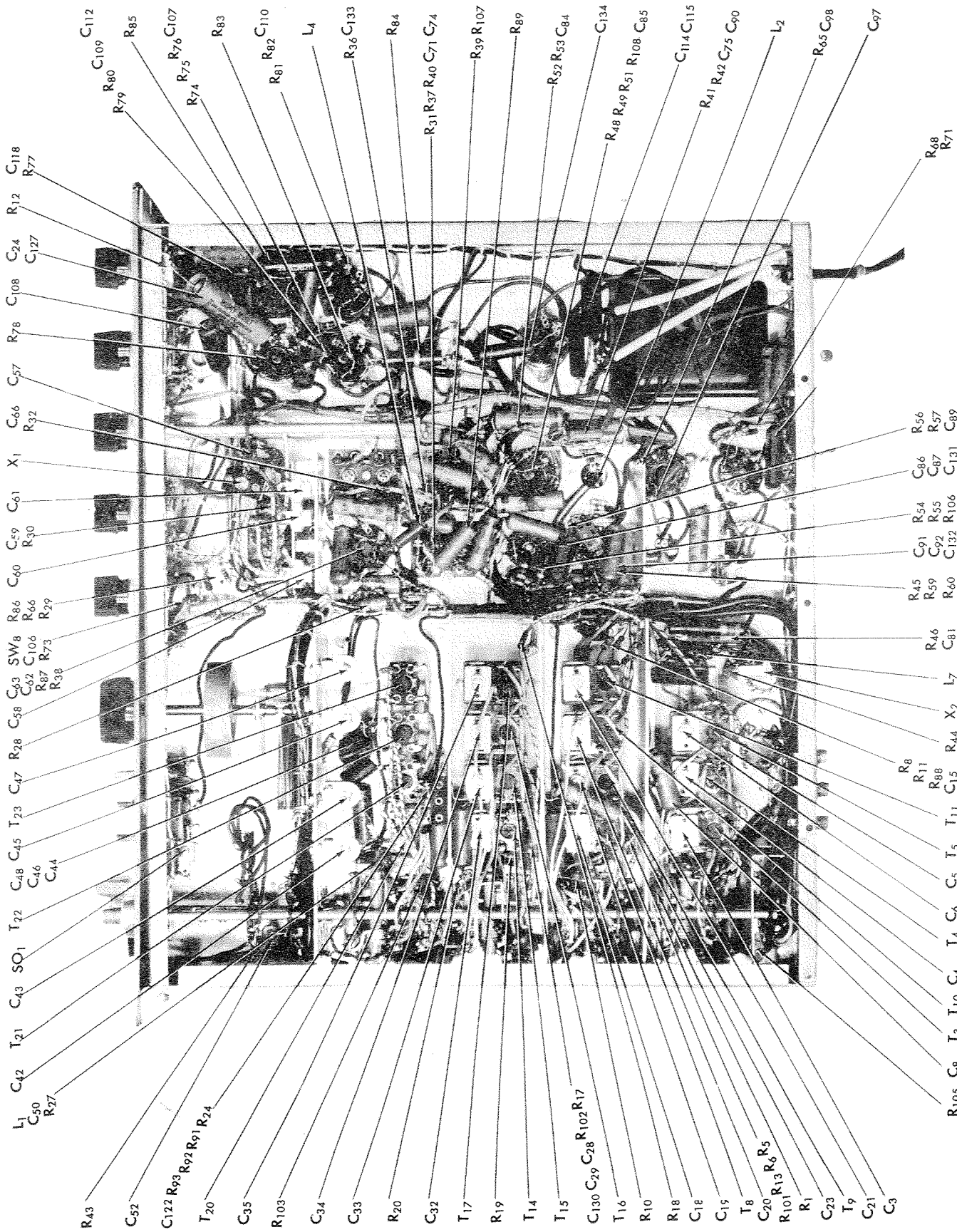
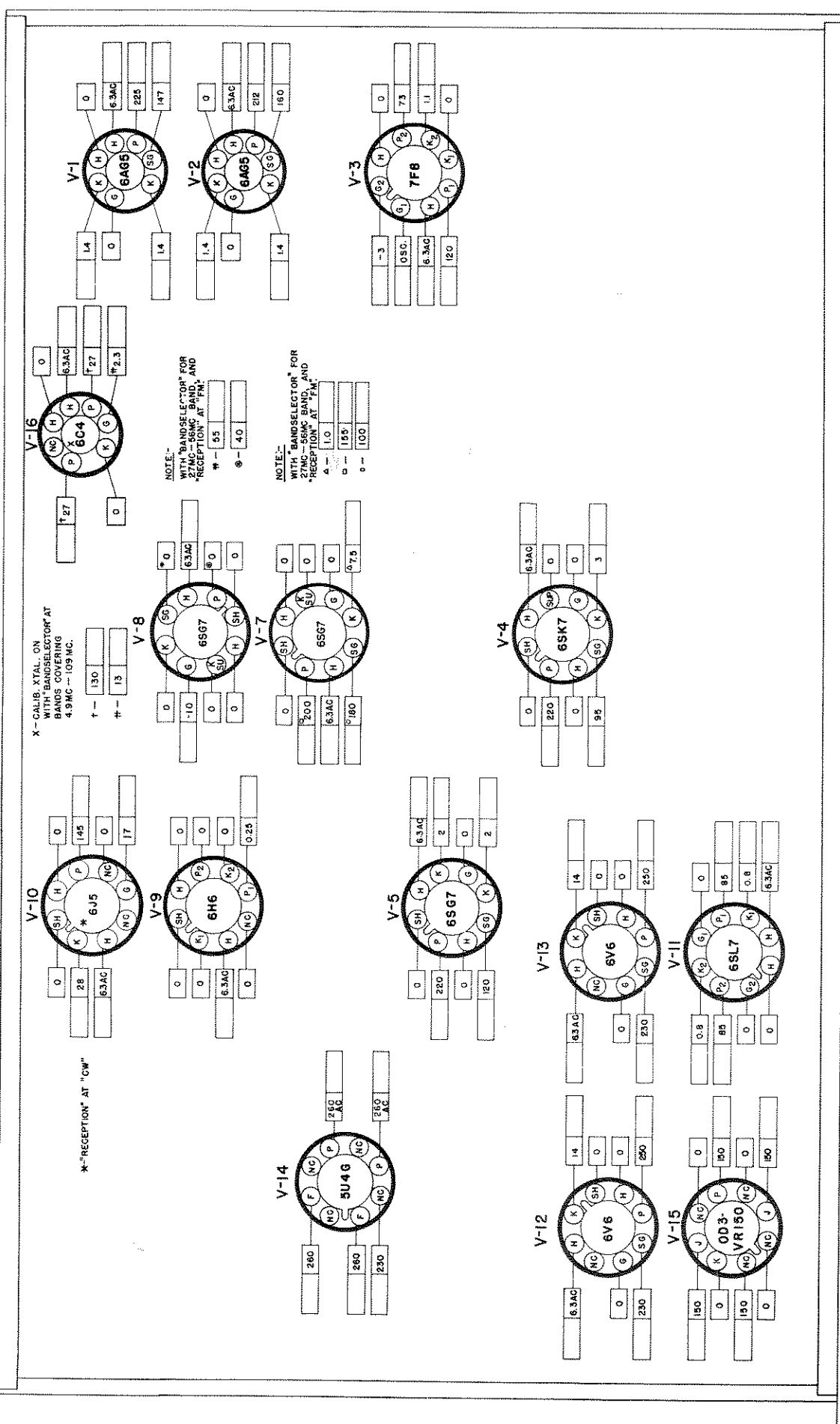

Figure 12. Component Locations, Bottom View

92X545



- FRONT PANEL NOTES (CONT.)
- B. CONTROL SETTING—UNLESS SPECIFIED  
 "BAND SELECTOR" AT BAND 1.  
 "RECEPTION" AT "AM".  
 "CALIB. XTAL" AT "OFF".  
 "NOISE LIGHTER" AT "OFF".  
 "RECEIVE - STANDBY" AT "RECEIVE".  
 "SENSITIVITY" AT MAXIMUM GAIN.  
 "SELECTIVITY" AT "NORMAL / BOARD".
- NOTES
1. SOCKET VIEWS ARE BOTTOM VIEWS.
  2. ALL VOLTAGES MEASURED BETWEEN TUBE SOCKET TERMINALS AND GROUND.
  3. LINE VOLTAGE — 117 V. AC.
  4. ALL VOLTAGES SHOWN ARE DC UNLESS OTHERWISE SPECIFIED.
  5. VOLTAGES SHOWN WERE MEASURED WITH A 20,000 OHM/VOLT METER.
  6. "NC" — NO CONNECTION.
  7. THE BLANK SPACES ARE PROVIDED FOR THE SERVICEMAN. FILL IN THE ACTUAL READING AS TAKEN WITH YOUR OWN EQUIPMENT. A NORMAL OPERATING RADIO SHOULD BE USED FOR THESE MEASUREMENTS.

Figure 13. Tube Socket Voltage Chart



# SERVICE PARTS LIST

Schematic Symbol	Description	Hallcrafters Part Number	Schematic Symbol	Description	Hallcrafters Part Number	Schematic Symbol	Description	Hallcrafters Part Number
<b>CAPACITORS</b>			<b>*RESISTORS (Cont)</b>			<b>TRANSFORMERS AND COILS (Cont)</b>		
C1, 2, 16, 17, 30, 31	Trimmers, adjustable; 2 section; antenna, RF amp, and mixer stages	044-200165	R26	5.6K ohms, 1 watt	451-352562	T27	Transformer, FM detector	050-300191
C3, 4, 18, 19, 20, 21, 32, 33, 34, 35	Part of transformers T3, 4, 5, 8, 9, 10, 11, 14, 15, and 17 respectively	-----	R27	470 ohms 20%	451-253471	T28	Transformer, BFO	050-300655
C5, 129, 130	2.2 mmf. 500V., bakelite	047-100160-04	R28	68K ohms, 1 watt	451-352683	T29	Transformer, audio output	055-300213
C7, 79	5 mmf. 500V., ceramic	491-002050-95	R29	120 ohms	451-252121	T30	Transformer, power; 115V. 50/60 cycles	052-300141
C8, 11, 25	.047 mfd. 200V., molded tubular	499-014473	R30	42,52 1 megohm 20%	451-253105	L1	RF choke (coded red)	053-200008
C9	Capacitor, main tuning	048-300204	R31, 60	330 ohms	451-252331	L2	IF coupling coil	053-200104
C13, 15, 27, 29, 50, 59, 63, 74, 86, 87, 91, 109, 112, 132	.022 mfd. 600V., molded tubular	499-031223	R36	1.2 megohms	451-252125	L3	Choke, filter	056-200087
C14, 28	5600 mmf. 500V., mica	470-514562	R37	100K ohms, 1 watt	451-352104	L4	RF choke; filament	053-100099
C22, 123	15 mmf. 500V., ceramic	491-006150-95	R38	270 ohms	451-252271	L5, 6	RF choke; screen (wound on R95 & R96)	053-100117
C23, 82, 70, 84	.047 mfd. 200V., molded tubular	499-011473	R39, 59, 87	56K ohms	451-252563	L7	RF choke; plate	053-100139
C24	.22 mfd. 200V., molded tubular	499-011224	R41, 49, 56, 79, 80, 81, 83	220K ohms	451-252224	<b>TUBES AND LAMPS</b>		
C36, 76, 78, 120	7 mmf. 500V., ceramic	491-006070-95	R44, 114	4.7 megohms	451-252475	V1, 2	Type 6AG5, 1st and 2nd RF amplifier	090-900791
C37, 97	47 mmf. 500V., mica	470-213470	R46	27K ohms, 2 watts	451-552273	V3	Type 7F8, oscillator/mixer	090-901145
C12, 26, 38, 75, 81, 92, 106, 114, 115, 117, 121, 122, 131, 133, 134, 135	.01 mfd. 600V., molded tubular	499-031103	R50	680 ohms	451-252661	V4	Type 6SK7, 1st IF amplifier	090-901233
C39, 49	110 mfd. 500V., ceramic	491-025111-95	R53	820K ohms	451-252824	V5	Type 6SG7, 2nd IF amplifier	090-901181
C40, 41, 57	Trimmer, adjustable; oscillator section bands 5 and 8; crystal phasing	044-100078	R55	10K ohms, 1 watt	451-352103	V7, 8	Type 6SG7, 3rd IF amplifier & AM detector	090-901163
C42	Trimmer, adjustable; oscillator section, band 4	044-100347	R56, 57, 71, 94	47K ohms	451-252473	V9	Type 6AL5; discriminator	090-901141
C43, 45	Trimmer, adjustable; oscillator section, bands 2 and 3	044-100077	R65	150K ohms	451-252154	V10	Type 6J5, BFO	090-901219
C44	4700 mmf. 2%, 500V., silver mica	470-521472	R66	1.5 megohms	451-252155	V11	Type 6SL7GT, phase inverter	090-901219
C46	1500 mmf. 2%, 500V., silver mica	470-421152	R68	5.1K ohms, 5%	451-251512	V12, 13	Type 6V6GT, AF power amplifier	090-901221
C47	Trimmer, adjustable; oscillator section band 1	044-100076	R73	Variable; Volume Control	025-100549	V14	Type 5AU4G, rectifier	090-900719
C48	478 mmf. 2%, 500V., silver mica	470-231471	R76, 92	56 ohms	451-252560	V15	Type OD3/VR150, voltage regulator	090-901234
C51	220 mmf. 2%, 500V., silver mica	470-341221	R77	1K ohm, 2 watts	451-552102	V16	Type 6C4, calibration oscillator	090-900830
C52, 66, 71, 99, 108, 118, 137	.047 mfd. 500V., molded tubular	499-031473	R82	6.2K ohms	451-252822	LM1, 2, 3, 4, 5, 6, 7, 8, 9, 10, 11, 12	Lamp, pilot; 6-8V	039-100003
C58, 60, 61	Trimmer, adjustable; crystal phasing	044-200184	R84	220 ohms, 2 watts	451-552221	<b>SWITCHES</b>		
C89, 90	180 mmf. 500V., mica	470-213181	R85	2K ohms, 5%, 10 watts; WW	453-061202	SW1	Switch, BAND SELECTOR	060-400329
C98	560 mmf. 500V., mica	470-313561	R88	2.2 megohms 20%	451-253225	SW2	Switch, SELECTIVITY	060-100234
C107	10 mfd. 25V., electrolytic	045-100121	R89	68K ohms	451-252883	SW3	Switch RECEPTION	060-002673
C110	680 mmf. 500V., mica	470-313681	R91, 93	4.7K ohms	451-252472	SW4	Switch, TONE	060-300236
C111, 113, 118	20 mfd. 25V., 30-20 mfd. 450V. electrolytic	045-100041	R101, 102	330 ohms 20%	451-253331	SW5, 6, 7	Switch, toggle; SPST	060-100138
C127	100 mfd. 25V., electrolytic	045-100116	R105	100 ohms	451-252101	SW8	Switch, power (part of volume control R73)	-----
C136	.01 mfd. 20%, 500V., ceramic	047-100354	R110, 111	1 megohms	451-252105	<b>PLUGS AND SOCKETS</b>		
C138, 139	.01 mfd. 40-20%, 600V., ceramic	047-100217	R112	100K ohms	451-252104	PL2	Plug and cord, power	087-100078
C140	10 mmf. 500V., ceramic	491-002100-092	R113	1.5 megohms, 5%	451-251155	SO2	Jack, PHONE	036-200004
<b>*RESISTORS</b>			<b>*All Resistors are 10%, 1/2 watt, carbon type unless otherwise noted.</b>			<b>TRANSFORMERS AND COILS</b>		
R1, 10, 51	100K ohms 20%	451-253104	<b>T1</b>			SO3	Jack, PHONE	036-100041
R2	12 ohms	451-252120	<b>Transformer, antenna stage; band 6</b>			Socket, dial lamp	086-200073-01	
R3, 15	150 ohms	451-252151	<b>T2</b>			Socket, octal; black molded	006-200296	
R4, 54	47K ohms, 1 watt	451-352473	<b>Transformer, antenna stage; band 5</b>			Socket, octal; mica	006-100223	
R5, 9, 14, 19, 90, 103, 104	15 ohms 20%	451-253150	<b>T3</b>			Socket, miniature 7 pin; mica	006-100268	
R6, 13, 17, 20	2.2K ohms 20%	431-253222	<b>Transformer, antenna stage; band 4</b>			Socket, miniature 7 pin; molded bakelite	006-100292	
R7, 18, 40, 67, 74, 78	1.2K ohms	451-252122	<b>T4</b>			Socket, octal	006-100250	
R8, 43, 109	470K ohms 20%	451-253474	<b>Transformer, antenna stage; band 3</b>			Socket, miniature 7 pin	006-001122	
R12	Variable; Sensitivity Control	025-100546	<b>T5</b>			<b>MISCELLANEOUS</b>		
R16, 22, 32, 45, 65, 106, 110	1K ohm 20%	451-253102	<b>Transformer, antenna stage; band 1</b>			X1	Clip, dial scale & window mtg.	076-100403
R21, 107	2.2 megohms	451-252225	<b>T6</b>			X2	Crystal, calibration; 500KC	019-100123
R23	47 ohms 20%	451-253470	<b>Transformer, RF stage; band 5</b>				Dial cord (specify length)	038-100026
R24	33 ohms 20%	451-253330	<b>T7</b>			CR1	Diode, Type 1N3182	082-300301
R25, 75	10K ohms	451-252103	<b>Transformer, RF stage; band 4</b>			CR2	Diode, Type 1N456	019-003316
			<b>T8</b>				Escutcheon	007-400078
			<b>Transformer, RF stage; band 3</b>				Flywheel, dial drive	071-100178
			<b>T9</b>			F1	Fuse, 2 amp. 250V; type 3AG	039-100428
			<b>Transformer, antenna stage; band 2</b>				Fuse holder	006-100451
			<b>T10</b>				Knob, BAND SELECTOR OR TUNING	015-001593
			<b>Transformer, mixer stage; band 2</b>				Knob, POINTER RESET	015-001609
			<b>T11</b>				Knob, RECEPTION, SELECTIVITY, TONE, VOLUME & SENSITIVITY control	076-000397-01
			<b>Transformer, mixer stage; band 1</b>				Lock, line cord; male section	076-000397-02
			<b>T12</b>				Lock, line cord; female section	016-100029
			<b>Transformer, mixer stage; band 3</b>				Mounting foot; rubber	028-300111
			<b>T13</b>				Pulley, Assembly	074-100252
			<b>Transformer, oscillator stage; band 6</b>				Shaft, general coverage dial	074-002650
			<b>T14</b>				Shaft index control	075-100012
			<b>Transformer, oscillator stage; band 5</b>				Spring, 3/4 in. Lg.	075-100893
			<b>T15</b>				Spring, 7/8 in. Lg.	088-200976
			<b>Transformer, oscillator stage; band 4</b>			TS1	Terminal strip, antenna	088-200936
			<b>T16</b>			TS2	Terminal strip, speaker	076-100552
			<b>Transformer, oscillator stage; band 3</b>				Ring, Retaining; index control shaft	022-300214
			<b>T17</b>				Window, dial	
			<b>Transformer, oscillator stage; band 2</b>					
			<b>T18</b>					
			<b>Transformer, oscillator stage; band 1</b>					
			<b>T19</b>					
			<b>Transformer, oscillator stage; band 6</b>					
			<b>T20</b>					
			<b>Transformer, oscillator stage; band 5</b>					
			<b>T21</b>					
			<b>Transformer, oscillator stage; band 4</b>					
			<b>T22</b>					
			<b>Transformer, oscillator stage; band 3</b>					
			<b>T23</b>					
			<b>Transformer, oscillator stage; band 2</b>					
			<b>T24</b>					
			<b>Transformer, oscillator stage; band 1</b>					
			<b>T25</b>					
			<b>Transformer, 1st IF amp. stage</b>					
			<b>T26</b>					
			<b>Transformer, 2nd IF amp. stage</b>					
			<b>Transformer, 3rd IF amp. stage</b>					

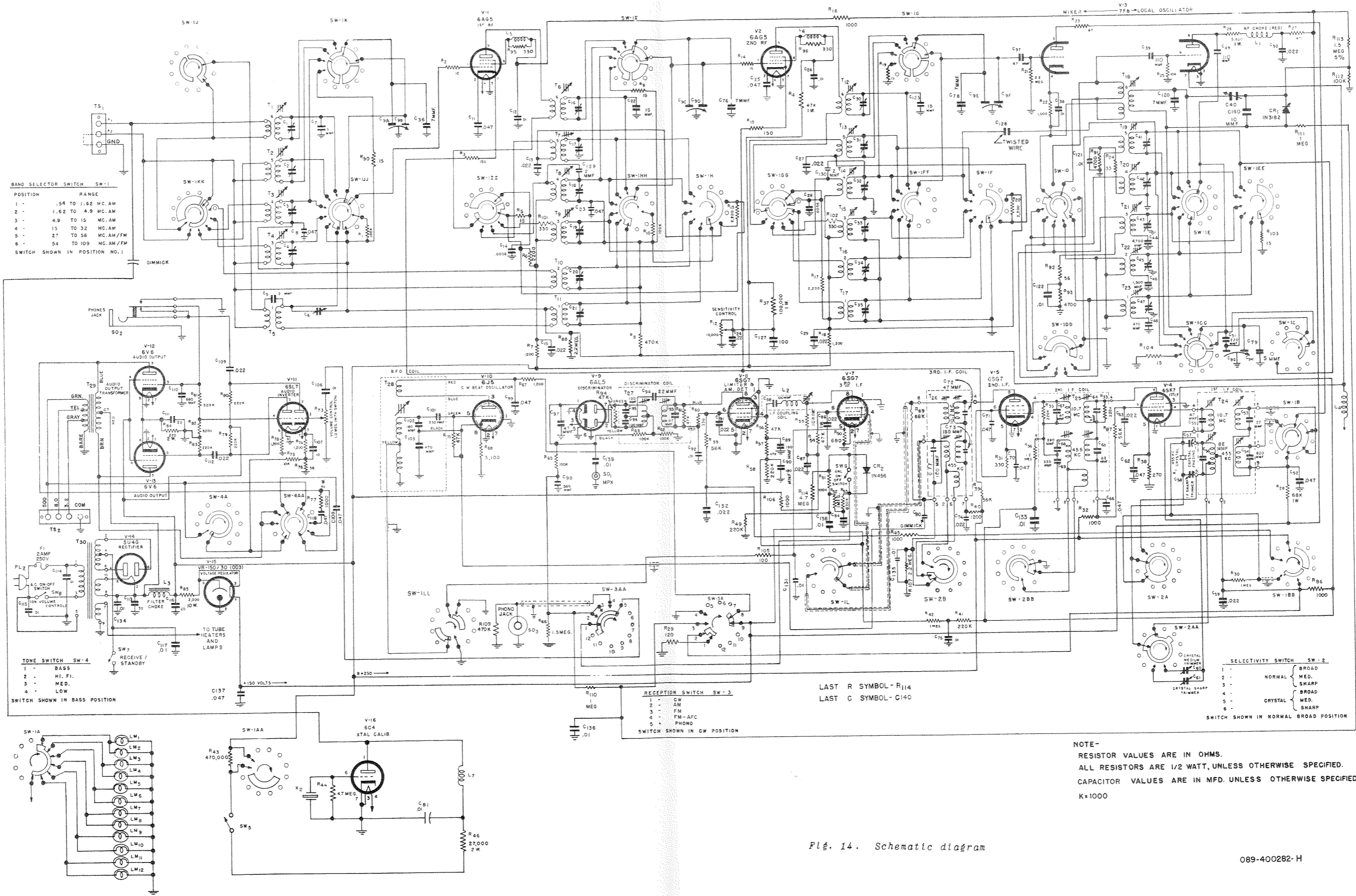

**BAND SELECTOR SWITCH SW-1**

POSITION	RANGE
1	.54 TO 1.62 MC. AM
2	1.62 TO 4.9 MC. AM
3	4.9 TO 15 MC. AM
4	15 TO 32 MC. AM
5	27 TO 56 MC. AM/FM
6	54 TO 109 MC. AM/FM

SWITCH SHOWN IN POSITION NO. 1

**RECEIVE / STANDBY SWITCH SW-7**

1	RECEIVE
2	STANDBY

SWITCH SHOWN IN BASS POSITION

**RECEPTION SWITCH SW-3**

1	CW
2	AM
3	FM
4	FM-AFC
5	PHONO

SWITCH SHOWN IN CW POSITION

**SELECTIVITY SWITCH SW-2**

1	BROAD
2	NORMAL
3	MED. SHARP
4	BROAD
5	CRYSTAL MED. SHARP
6	CRYSTAL SHARP

SWITCH SHOWN IN NORMAL BROAD POSITION

LAST R SYMBOL - R<sub>114</sub>  
 LAST C SYMBOL - C<sub>140</sub>

NOTE -  
 RESISTOR VALUES ARE IN OHMS.  
 ALL RESISTORS ARE 1/2 WATT, UNLESS OTHERWISE SPECIFIED.  
 CAPACITOR VALUES ARE IN MFD. UNLESS OTHERWISE SPECIFIED.  
 K=1000

Fig. 14. Schematic diagram



