

Engineering



Communications

**OPERATING and SERVICE
INSTRUCTIONS**



the hallicrafters co.
MANUFACTURERS OF RADIO AND ELECTRONIC EQUIPMENT, CHICAGO 24, U. S. A.

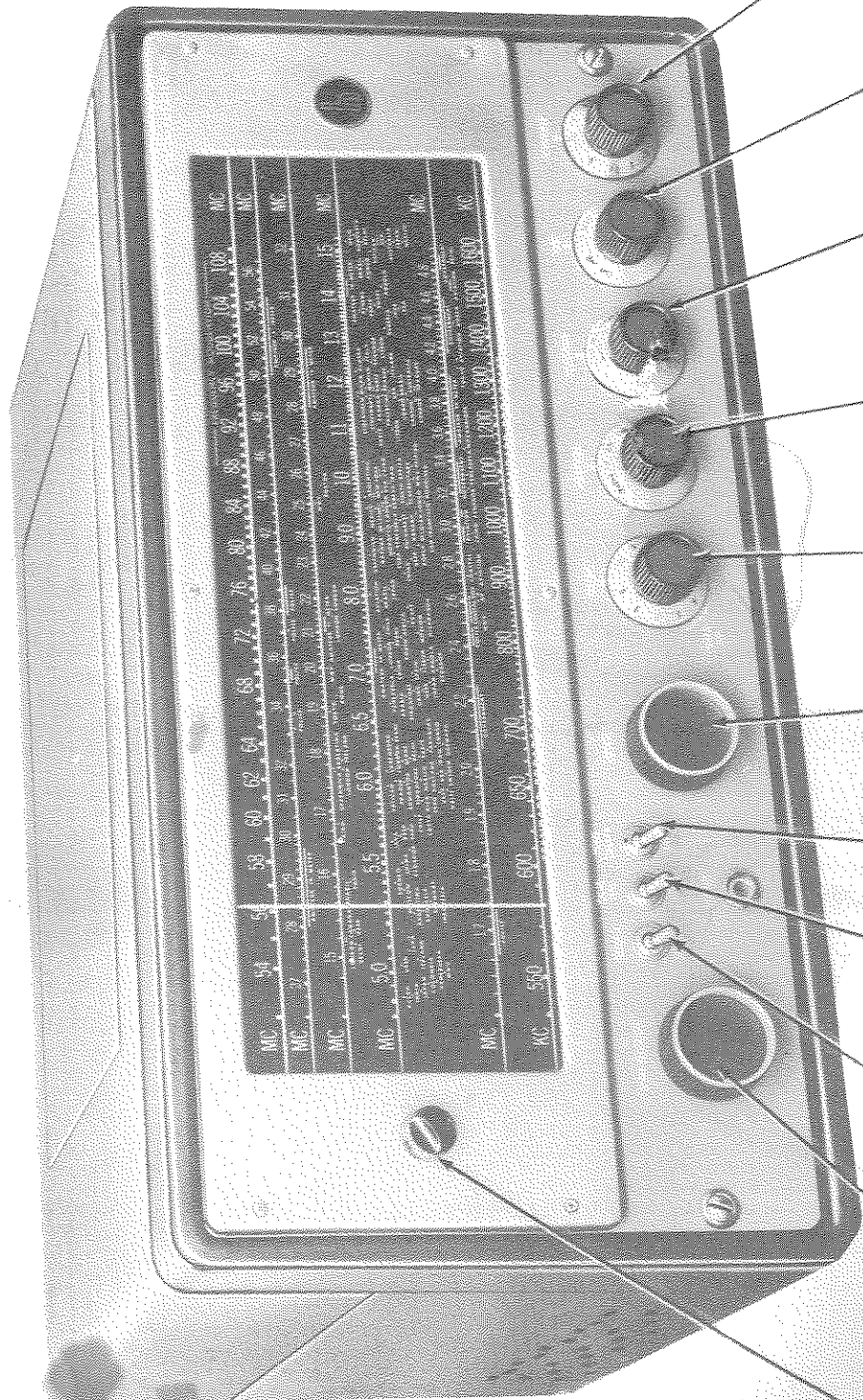

SENSITIVITY CONTROL

- RECEIVE - BAND
- STANDBY SELECTOR SWITCH
- NOISE LIMITER SWITCH
- TUNING CONTROL
- VOLUME CONTROL
- RECEPTION CONTROL
- SELECTIVITY CONTROL
- STONE CONTROL

Fig. 1. Radio Receiver Model SX-62/62U

924519-A

SX62

GENERAL SPECIFICATIONS

Tubes Fourteen plus voltage regulator and rectifier

Speaker Output 500/5000 ohms

Headset Output High impedance

Antenna Input For 50 to 600 ohm line or single wire lead-in

Phono Input High impedance

External Power Connector . . Std. octal socket

Tuning Range See Frequency Coverage

Intermediate Frequency . . . 455 kc/10.7 mc

Power Supply Standard Model 105-125
V. 60 Cycles AC

Universal Model 105-250
V. 25/100 Cycles AC

Power Consumption 120 Watts

FREQUENCY COVERAGE

BAND	FREQUENCY RANGE	TYPE OF RECEPTION
1	550 KC - 1620 KC	AM/CW
2	1.62 MC - 4.9 MC	AM/CW
3	4.9 MC - 15 MC	AM/CW
4	15 MC - 32 MC	AM/CW
5	27 MC - 56 MC	AM/FM/CW
6	54 MC - 109 MC	AM/FM/CW

AM - Amplitude Modulation

FM - Frequency Modulation

CW - Code.

The Model SX-62/62U receiver is a sensitive high fidelity superheterodyne receiver covering all of the broadcasting services between 540 kilocycles (KC) and 109 megacycles (MC). The receiver is capable of receiving both the FM (Frequency Modulation) and AM (Amplitude Modulation) broadcasts transmitted in this frequency range as shown in the FREQUENCY COVERAGE chart.

A built-in 500 kc crystal controlled calibrating oscillator and adjustable dial pointer permit accurate dial calibration on the large direct reading slide rule dial. Marker signals appear every 500 kc on the dial scale with this type of marker oscillator; hence, dial calibration may be held to very close limits over the entire dial scale by comparison with the marker signal.

This calibration feature of the Model SX-62 receiver makes it possible to log the most prominent shortwave stations by countries directly on the dial. In addition, many of the active communication channels; government, amateur, police, aviation, etc. are logged by bars to indicate their location on the dial. World-wide reception is accomplished simply by selecting the desired frequency band (band selector switch) and adjusting the tuning control so that the pointer is above the station locating dot.

The receiver selectivity is adjustable to accommodate the broad response required for high fidelity FM and AM broadcast reception to the sharpest crystal selectivity required for code reception in the crowded channels of the short wave bands.

The high fidelity tone compensated audio system provides four distinct tone ranges covering full range reception for entertainment purposes as well as the restricted range required for communication work in either voice or code.

An automatic noise limiter, operated by a toggle switch, permits the operator to reduce the background noise caused by severe electrical disturbances. Background noise is reduced in the model SX-62 with a minimum of audio distortion.

A RECEIVE-STANDBY switch permits receiver disabling for short standby periods without having to wait for the tube heaters to reach operation temperature when reception is again required.

The receiver normally operates from a 105-125 volt 60 cycle alternating current (AC) source. A connector for operating the receiver with external batteries or equivalent power is provided to permit operation in areas where AC current does not exist. A universal model of the SX-62 receiver permits operation from 25/to 100 cycle alternating current sources operating at voltages ranging from 105-250 volts. The power requirements for your receiver must be checked carefully. Read over the installation section of this book before connecting to your power source.

INSTALLATION

UNPACKING - Check all shipping instruction tags carefully before removing them.

LOCATION - The receiver is equipped with rubber feet for table top or shelf mounting. When locating the receiver, avoid excessively warm locations such as near radiators, hot air registers, or confined dead air spaces such as are encountered in recessed installations.

POWER SOURCE - Two types of power sources may be used to operate the receiver. The receiver may be operated directly from an AC source or indirectly from an AC source or indirectly from a battery or DC source as follows:

AC operation - The receiver, as normally supplied, operates from a 105 to 125 volt, 50/60 cycle AC outlet. Power consumption is approximately 120 watts. If you are in doubt or unfamiliar with the voltage and frequency rating of your utility service, consult your local power company representative. Attempting to operate the receiver from other sources of power than specified may involve costly repairs.

A universal model is available for operation from 115 V./130 V./150 V./220 V./250 V. 25/100 cycle AC sources. A selector switch on the power transformer permits operation on any of the line voltages shown.

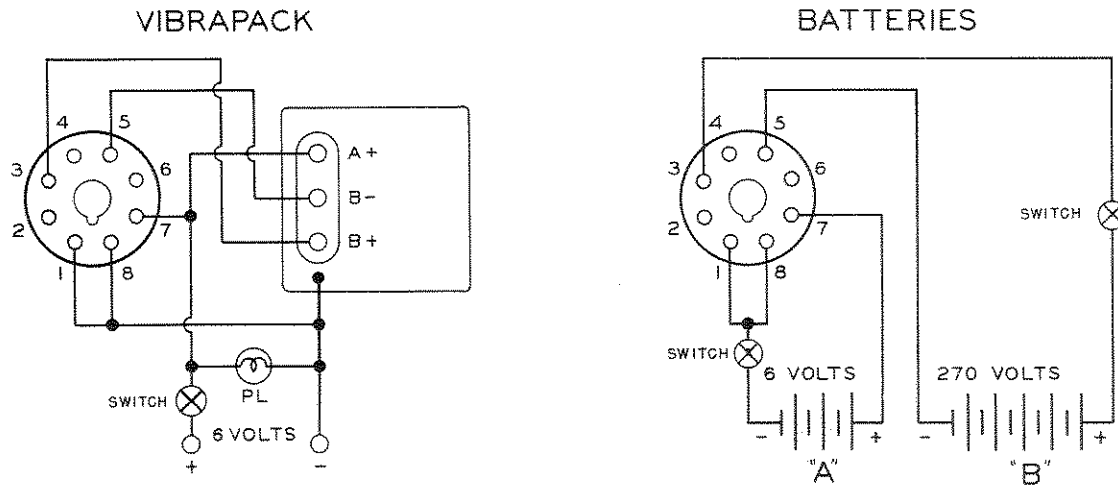

Fig. 2. Wiring diagrams DC power plug.

928520

CAUTION - When operating the universal model, it is necessary to check, and set if necessary, the selector switch on the power transformer before connecting the receiver to the source of power.

Note - The receiver will not operate from an AC source unless the jumper plug is located in its BATTERY POWER receptacle. See Fig. 2.

DC Operation - The receiver may be operated from a 6-volt DC source (storage battery or equal) and a 270-volt DC supply in the form of "B" batteries, vibrator power pack, or motor generator set. The DC source must be capable of supplying the following voltages and currents for optimum results.

- "B" voltage 270 Volts
- "B" current 150 Milliamperes
- Heater voltage 6.3 Volts
- Heater current 5 Amperes

Total current drain, when operating entirely from a storage battery, will run approximately 15 to 20 amperes.

DC power is connected to the receiver through the octal socket located on the rear apron of the chassis. The jumper plug normally in this socket for AC operation is replaced with a standard octal plug for DC operation.

Wire the octal plug for DC operation as shown in Fig. 2.

SPEAKER CONNECTION - Three screw type terminals, located on the rear chassis apron, are provided for the speaker connection. The output impedances available are 500 and 5000 ohms. Any suitable speaker unit which will operate with either of these output impedances may be used with the Model SX-62 receiver. Hallicrafters Model PM-23 speaker connects to the 5000-ohm terminals (marked "COM/5000"); the Model R-42 and R-44 speaker units connect to the 500-ohm terminals (marked "COM/500").

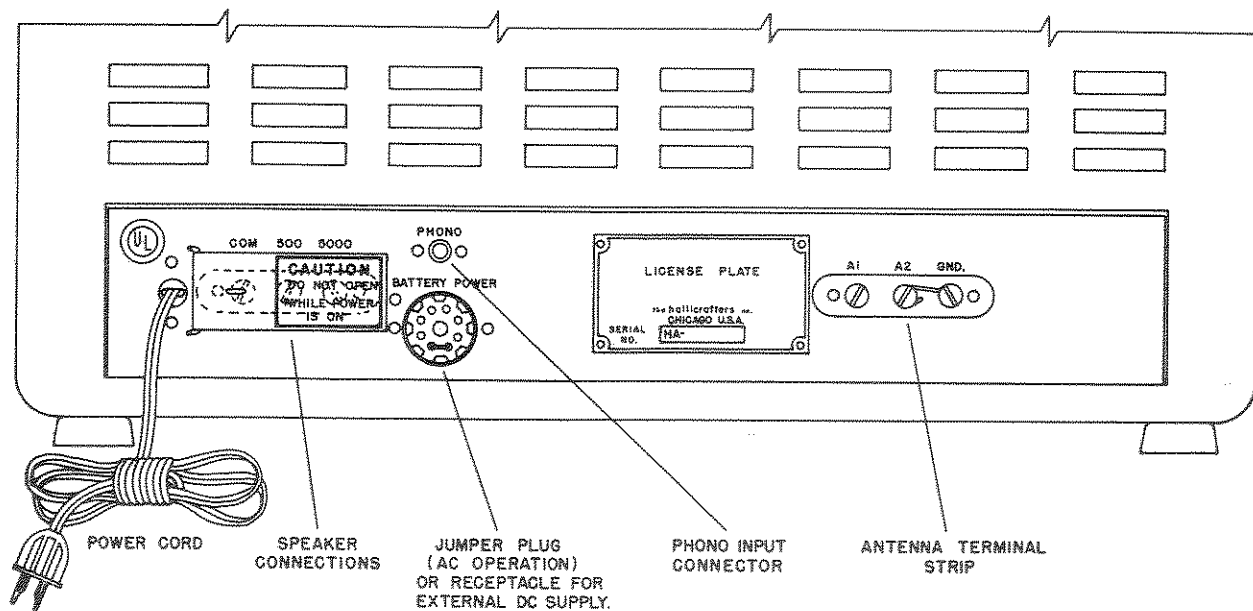

920521

Fig. 3. Rear view.

ANTENNA - A three terminal strip marked "A1", "A2" and "GND" is provided at the rear chassis apron for antenna connections. This terminal arrangement will accommodate either a single wire antenna lead-in or antenna transmission line.

Single Wire Antenna - For a single wire antenna installation, connect a jumper between the antenna terminals "A2" and "GND". A single wire antenna about 50 to 100 feet long (including lead-in) is then connected to terminal "A1". Erect the antenna as high and free of surrounding objects as possible. This type of antenna must be well insulated from ground for best results. It may be desirable in some installations to connect a ground wire between terminal "GND" and a suitable ground such as a water pipe or outside ground stake.

Doublet Antenna - The doublet antenna is recommended for the high frequency bands, especially where a maximum signal to noise level is required over a relatively narrow range of frequencies. The antenna transmission line is connected to terminals "A1" and "A2". If a concentric line with a grounded outer conductor is used, connect the inner conductor to terminal "A1", the outer conductor to terminal "A2", and connect a jumper wire between terminals "A2" and "GND".

The overall length (feet) of a doublet antenna may be determined by dividing the constant 468 by the desired frequency in megacycles. Keep in mind that this type of antenna is directional broadside to its length and should be so oriented if maximum pickup from a given direction is desired.

In general the receiver will work well with antennas terminating in impedances ranging from 50 to 600 ohms. Some installations may require a ground wire connection such as a water pipe or outside ground stake.

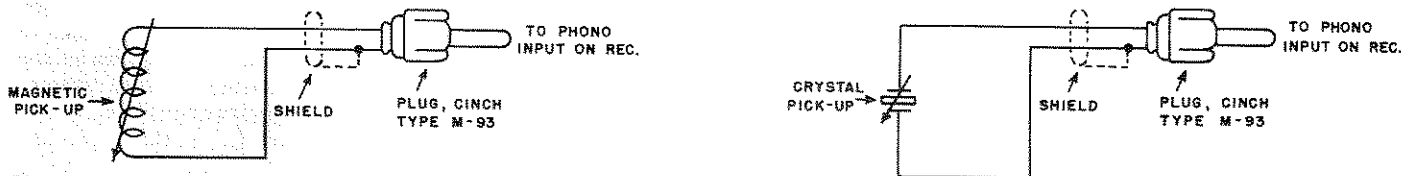

928522

Fig. 4. Wiring diagram, record player connection.

RECORD PLAYER CONNECTION - A shielded type receptacle is provided at the rear chassis apron to accommodate a record player pickup cable connector. Any record player employing a crystal cartridge or high level magnetic pickup in its tone arm may be used with the receiver. Refer to Figure 4. for wiring details.

OPERATION

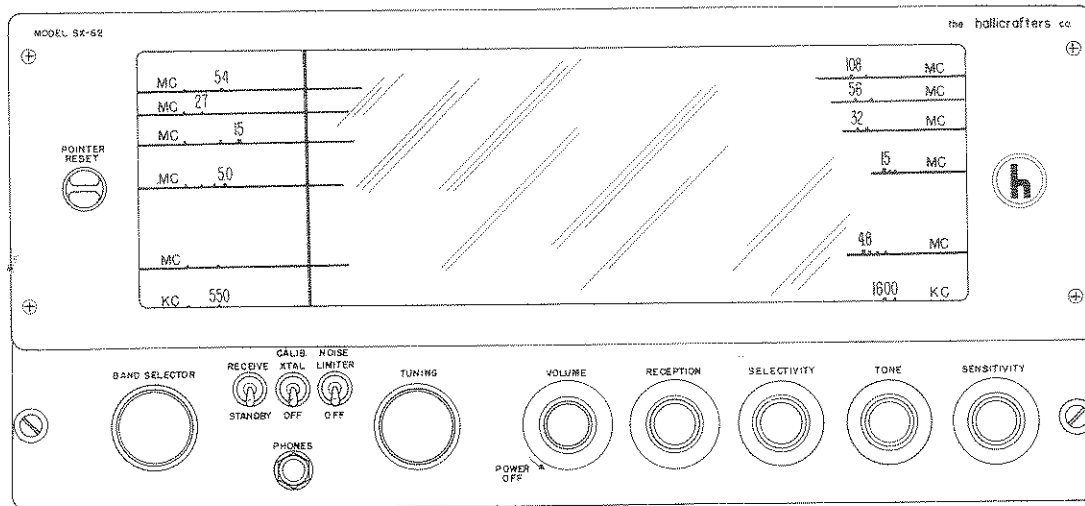

Fig. 5. Front view, location of controls

92C523-A

GENERAL BROADCAST RECEPTION - Certain front panel controls have been color coded to simplify the tuning procedure for general entertainment purposes. High fidelity reception in the standard broadcast (AM) and frequency modulation (FM) bands may be accomplished as follows: Turn the volume control clockwise beyond the tell tale click of the switch. This turns the receiver on as indicated by the illumination of one of the dial scales. Similarly the receiver is turned off by turning the control counter-clockwise beyond the click of the switch. At this point the three "bat-handle" switches may be set at "RECEIVE" and "OFF" and forgotten. To receive standard broadcast (AM) services; set the BAND SELECTOR for the position that illuminates the 550-1620 kilocycle scale (bottom scale), set the RECEPTION, SELECTIVITY, TONE and SENSITIVITY controls per the red dot, and adjust the TUNING and VOLUME controls in the normal manner, tuning for clearest reception as usual.

OPERATION FOR RADIO TELEPHONE AND CW

CONTROL	RADIO-TELEPHONE	CW
VOLUME control -	This control turns the receiver on and off in addition to controlling the volume. Turn the control clockwise to turn on the receiver or increase volume, and counter-clockwise to reduce volume or turn off the receiver.	Same
RECEIVE/STANDBY switch -	Normally set at "RECEIVE". May be set at "STANDBY" to disable the receiver for short standby periods and yet keep the tube heaters at operating temperature for instant use.	Same
RECEPTION control -	Set at "AM" for reception of amplitude modulated stations located in the standard broadcast band or any of the shortwave bands, or at "FM" for reception of FM stations located in the two highest frequency ranges (two top dial scales).	Set at "CW"
BAND SELECTOR -	Set for position that illuminates the dial scale covering the desired band of frequencies. Extreme left hand position of this control illuminates the lowest dial scale.	Same
TUNING control -	The tuning control sets the frequency of reception, tuning the band of frequencies shown on the illuminated dial scale. The frequency of reception is shown in kilocycles (KC) on the standard broadcast range and in megacycles (MC) on the shortwave and FM ranges. The frequencies of the local stations are generally listed in newspapers, AM stations in kilocycles and FM stations in megacycles. Information on short wave stations, not identified directly from the dial, may be obtained from published log books available at most book stores or radio supply houses. When tuning for the station, tune carefully for the clearest reception and obtain top performance from your receiver.	The tuning control sets the frequency of reception, tuning the band of frequencies shown on the illuminated dial scale. The frequency of reception is shown in megacycles (MC) on the shortwave bands used by code transmitters. When tuning for the station, tune for the pitch of the code signal found easiest to copy. The pitch of the code signal will usually run approximately 1000 cycles.

SELECTIVITY
control -

Normally set at "NORMAL/BROAD" for high fidelity reception in the standard broadcast and FM bands. Use the "NORMAL/MED." or "NORMAL/SHARP" for the more crowded conditions existing in most of the short-wave ranges. Note that as the receiver is made more selective, the background noise and interference from nearby stations is reduced. The setting of the selectivity control is generally best determined by receiving conditions, using just enough selectivity to isolate the desired stations. The "CRYSTAL/BROAD" position may be used when the frequency of reception is extremely congested.

This control may be set at "NORMAL/MED." OR "NORMAL/SHARP" for the reception of code stations not suffering local interference. Congested receiving conditions may be handled by increasing selectivity, switching to one of the three crystal positions for the degree of selectivity required. Note that in the crystal position the tuning of the receiver changes, i.e. the desired station will be very loud on one side of zero beat and very weak (crystal slot) on the other side.

SENSITIVITY
control -

Normally set maximum clockwise. Local high powered stations may overload the receiver, showing up as distortion, hence conditions may require that this control be turned counter-clockwise to reduce the sensitivity of the receiver accordingly.

The receiver sensitivity must be controlled manually for code reception, hence the SENSITIVITY control must be advanced just enough to keep the code stations from blocking the receiver.

TONE control -

Normally set at "HI-FI" or "BASS" for AM or FM entertainment purposes. The "LOW" and "MED." positions will be found desirable when listening on the shortwave bands.

Normally set at "LOW" or "MED." for code reception.

USE OF THE CALIBRATING CRYSTAL - A built-in secondary frequency standard and adjustable dial pointer permits accurate frequency calibration over any portion of the receiver dial. Three degrees of dial calibration accuracy may be had as follows:

1. General Dial Indexing - Run the dial pointer down to the left hand end of the dial scale, turning the TUNING knob until the left hand dial stop is reached. Line up the dial pointer with the index line using the small POINTER RESET knob located to the left of the dial escutcheon.
2. Average Dial Calibration - Index the dial pointer as described above. Set the CALIB. XTAL switch at "CALIB. XTAL", RECEPTION switch at CW, and tune the receiver to zero beat with the calibrating oscillator signal, i.e. the pitch of the whistle or beat note will pass through zero cycles at the exact center of the marker signal. The oscillator signals will be found at multiples of 500 kilocycles on the lower 5 dial scales, i.e. 1000 kc and 1500 kc; 2 mc, 2.5 mc, 3 mc etc.; 5 mc, 5.5 mc, 6 mc, etc.; 15 mc, 15.5 mc, 16 mc, etc.; or 27 mc, 27.5 mc, 28 mc, etc. After setting the TUNING control for zero beat, center the dial pointer exactly on the half-mega-cycle dial division. For best results, the receiver sensitivity must be held to a minimum while making calibration adjustments.
3. Precise Dial Calibration - To obtain a precise dial calibration the procedure outlined above should be repeated for the particular section of the dial in use rather than merely checking calibration at either end of the dial scale. Since the calibration signals appear every 500 kc along the dial, a calibration point may easily be obtained on either side of the frequency of reception at any point along the dial.

After calibrating the receiver dial with the calibrating crystal, the oscillator is switched OFF and the RECEPTION switch returned to the desired setting for normal reception.

RECORD PLAYER OPERATION - With a record player connected to the receiver it is merely necessary to set the RECEPTION control at PHONO and operate the VOLUME and TONE controls as for normal radio reception.

CAUTION - The receiver will not respond if the RECEIVE/STANDBY switch is set at "STANDBY". The setting of the remaining controls, except those mentioned above, is immaterial as they are not in use for record player operation.

HEADPHONE RECEPTION - A headset jack, located at the front panel, provides for headphone reception. Insertion of the headset plug disables the speaker. Any high impedance headset, magnetic or crystal, will work with the receiver.

SERVICE

TUBE REPLACEMENT - The types of tubes required and their relative position in the receiver are shown in the illustration, Fig. 6. When installing a replacement tube, insert the center guide pin into the center hole of the tube socket; rotate the tube until the key on the guide pin drops into the notch in the socket hole; and push down until the base of the tube rests firmly on the socket. A slightly different technique must be used on the miniature tubes. They have seven small pins which have to be lined up with the socket holes before pushing into place. Handle with care as all tubes are considered fragile and do not tolerate much mechanical abuse.

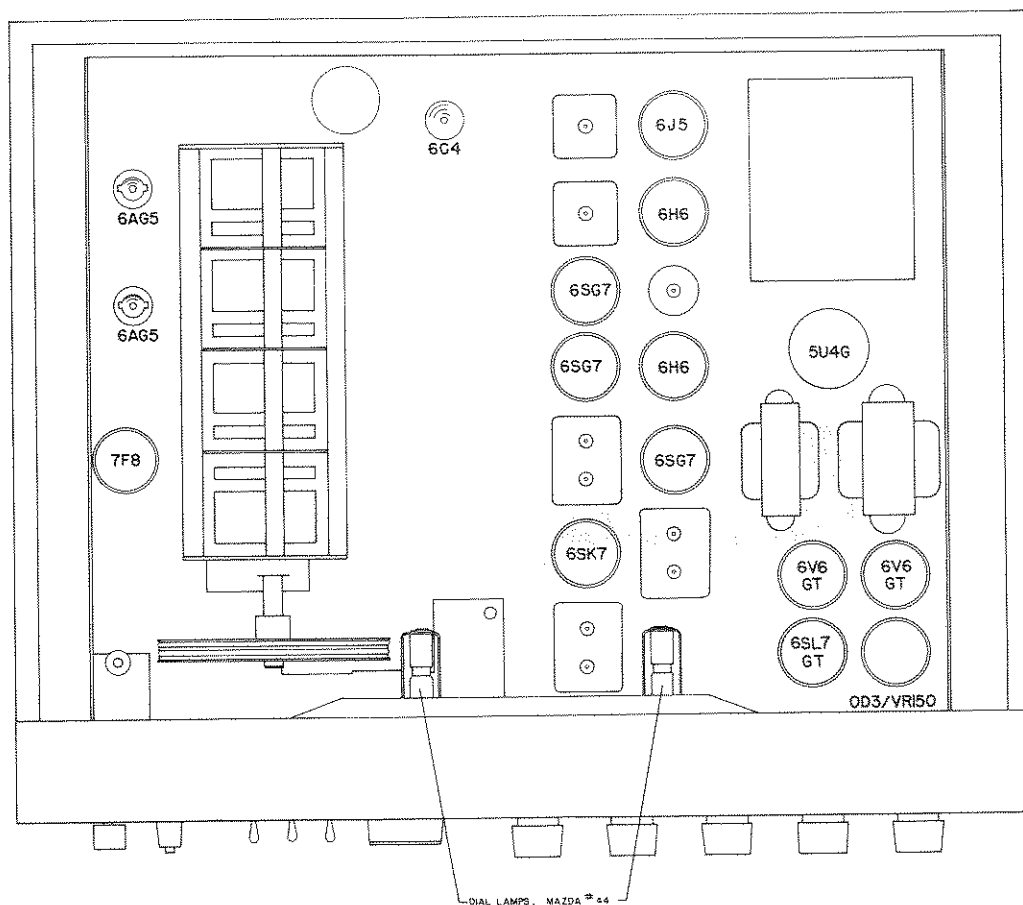

920524-A

Fig. 6. Top view showing location of tubes and dial lamps

DIAL LAMP REPLACEMENT - Refer to Fig. 6 for the location of the dial lamps used in the receiver. To gain access to defective lamps, open the cabinet cover, remove the light shield (four screws) and unclip the dial lamp socket by compressing the side springs. The socket may then be brought out into the open to change the defective lamps. Replace all lamps with 6-8 volt Mazda No. 44 (blue bead) or equivalent.

SERVICE OR OPERATING QUESTIONS - For further details regarding operation or servicing of the receiver, contact your dealer. Make no service shipments directly to the factory before first writing for authorization and instructions.

The factory cannot accept responsibility for unauthorized shipments.

The Hallicrafters Co. reserves the privilege of making revisions in current production of equipment and assumes no obligation to incorporate these revisions in earlier models.

POSITIONING CONTROL KNOBS

BAND SELECTOR . . . As required by flat on shaft
VOLUME Set at 10 for full clockwise rotation
RECEPTION As required by markings

SELECTIVITY . . . As required by markings
STONE As required by markings
SENSITIVITY . . . Set at 10 for full clockwise rotation

RESTRINGING DIAL CORD

Restring the tuning capacitor drive with a 45 inch length of 30 lb. test dial cord. Tie one end of the cord to the tension spring at position A and follow the stringing sequence A through J as shown. At position J stretch the tension spring and tie the cord securely to the spring. Note that the dial cord is wrapped around the tuning drive shaft two and three-quarters times for proper traction.

Restring the dial pointer drive with a 75 inch length of 30 lb. test dial cord. Tie one end of the cord to the tension spring at position 1 and follow the stringing sequence 1 through 12 as illustrated. At position 12 stretch the tension spring and tie the cord securely.

Index the dial pointer by setting the tuning gang at maximum capacity, the RESET control in the middle of its range, and aligning the pointer with the left hand dial index marker.

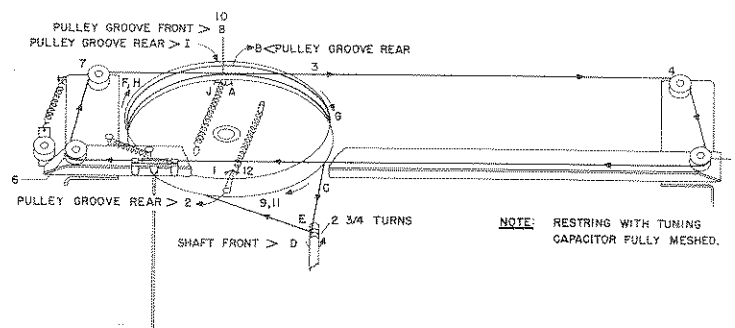

92C1481

Fig. 7. Dial cable stringing procedure

ALIGNMENT PROCEDURE

IF AMP ALIGNMENT (455 kc) - Set the controls as follows:

BAND SELECTOR 550/1620 kc range
RECEIVE/STANDBY switch . . RECEIVE
CALIB. XTAL switch OFF
NOISE LIMITER switch OFF
VOLUME control Near Maximum

RECEPTION control AM
SELECTIVITY control NORMAL/SHARP
SENSITIVITY control Near Maximum
Set tuning dial pointer at approximately 1,000 kc.

Connect high side of signal generator through an 0.1 mfd. capacitor to pin #1, of the 7F8 converter tube. With signal generator set at approximately 455 kc align slugs S-1, 3, 5, 10, 12 and 14 for maximum output.

Set RECEPTION control at CW and adjust slug S-8 for a 1,000 cycle note.

Set the SELECTIVITY control at CRYSTAL/BROAD. While slowly turning slug S-10 in one direction across the resonant setting obtained above, "rock" the signal generator tuning and observe the dip in the output meter reading as the adjustment passes through the response of the crystal filter. The correct setting of the slug S-10 is in the center of the observed dip. Set the signal generator at the weaker of the two responses obtained on either side of zero beat and adjust the crystal phasing trimmer C-57 for the null.

Set the SELECTIVITY control at CRYSTAL/SHARP and with trimmer C-61 set near minimum capacity, slowly increase its capacity while "rocking" the signal generator and adjust for maximum output. It may be necessary at this point to reduce the signal generator input and the receiver sensitivity to prevent overloading. After peaking the adjustment turn the trimmer in until a drop in output of about 2 db occurs. At this point the sharp crystal will have very good selectivity without sacrificing too much gain.

Tune the signal generator to exact crystal frequency and note output meter reading. Set the SELECTIVITY control at CRYSTAL/BROAD and note the drop in output, and output meter reading. Now switch to CRYSTAL/MEDIUM and with trimmer C-60 near minimum capacity, slowly increase its capacity, while "rocking" the signal generator, until the output meter indicates about midway between the output readings obtained in sharp crystal and broad crystal position.

Set the SELECTIVITY control at CRYSTAL/SHARP and reset signal generator for the exact crystal frequency. Switch to NORMAL/SHARP and reset slugs S-1,3,5 12,14 and trimmer C-58 for maximum output.

Set the RECEPTION control at CW and adjust the BFO slug S-8 for zero beat.

IF AMP. ALIGNMENT (10.7 mc) - Set the controls as follows:

BAND SELECTOR 27/56 mc range
RECEIVE/STANDBY switch . . RECEIVE
CALIB. XTAL switch OFF
NOISE LIMITER switch OFF
VOLUME Near Maximum

RECEPTION control AM
SELECTIVITY control NORMAL/SHARP
SENSITIVITY control Near Maximum
Set tuning dial pointer at approx. midscale.

Connect the high side of the signal generator through an 0.1 mfd. capacitor to pin #1 of the 7F8 converter tube. Set signal generator at 10.7 mc and adjust slugs S-4,6,9,13 and 15 for maximum output. Now set slugs S-2 and S-11 for maximum output but do not readjust slugs S-4 6,9, 13 and 15.

Set RECEPTION control at CW and adjust slugs S-17 for zero beat.

Set RECEPTION control at FM and adjust slug S-16 for maximum output. Now set Slug S-7 for the null or minimum output as indicated on the output meter. Check the discriminator by slowly tuning the signal generator through 10.7 mc and observe the two maximum audio level readings on the output meter. If the two peaks are equal the job is done; if not it may be necessary to reset Slug S-16 until a reasonable balance is obtained.

RF AMP ALIGNMENT

After completing the alignment of the IF amplifier stages the RF amplifier stages may be aligned according to the following chart. Connect the high side of the signal generator to terminal A-1 through the dummy antenna specified and connect a jumper between antenna terminal A-2 and GND. Use just enough signal generator output to obtain a 500 milliwatt audio output level for best results.

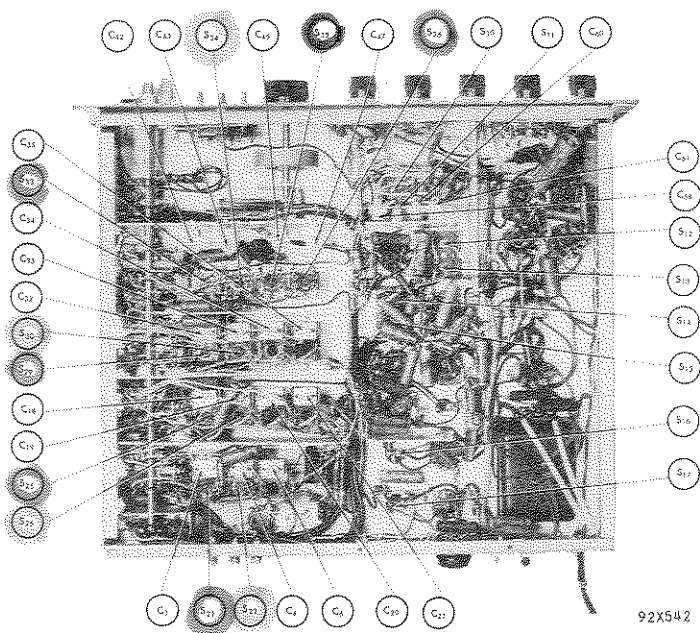

Fig. 8. Alignment adjustments, bottom view

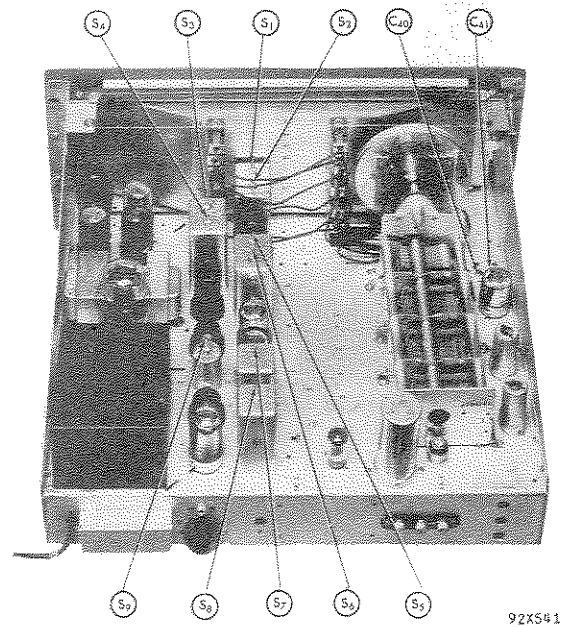

Fig. 9. Alignment adjustments, top view

ALIGNMENT CHART

Dummy Antenna	Signal Generator Frequency	Band Selector Range	Radio Dial Setting	Adjust	Remarks
RMA	1500 kc	<u>550-1600 kc</u>	1500 kc	C-47*, 6, 21, 35	Adjust for max. output
	600 kc		600 kc	S-36*	
RMA	4.5 mc	<u>1.62-4.9 mc</u>	4.5 mc	C-45*, 20, 34	Adjust for max. output
	2.0 mc		2.0 mc	S-35*	
RMA	14.0 mc	<u>4.9-15 mc</u>	14.0 mc	C-43*, 4, 19, 33	Adjust for max. output
	7.0 mc		7.0 mc	S-34*, 22, 26, 30	
RMA	28 mc	<u>15-32 mc</u>	28 mc	C-42*, 3, 18, 32	Adjust for max. output
	18 mc		18 mc	S-33*, 21, 25, 29	
300-ohm non-inductive resistor	50 mc	<u>27-56 mc</u>	50 mc	C-41*, 2, 17, 31	Adjust for max. output
	30 mc		30 mc	S-32*, 20, 24, 28	
300-ohm non-inductive resistor	105 mc	<u>54-109 mc</u>	105 mc	C-40*, 1, 16, 30	Adjust for max. output
	60 mc		60 mc	S-31*, 19, 23, 27	

* Note - Calibration adjustment.

Note - The standard RMA dummy antenna mention in the alignment chart consists of a 200 mmf condenser in series with a 20 uh r-f choke which is shunted by a 400 mmf condenser in series with a 400 ohm carbon resistor.

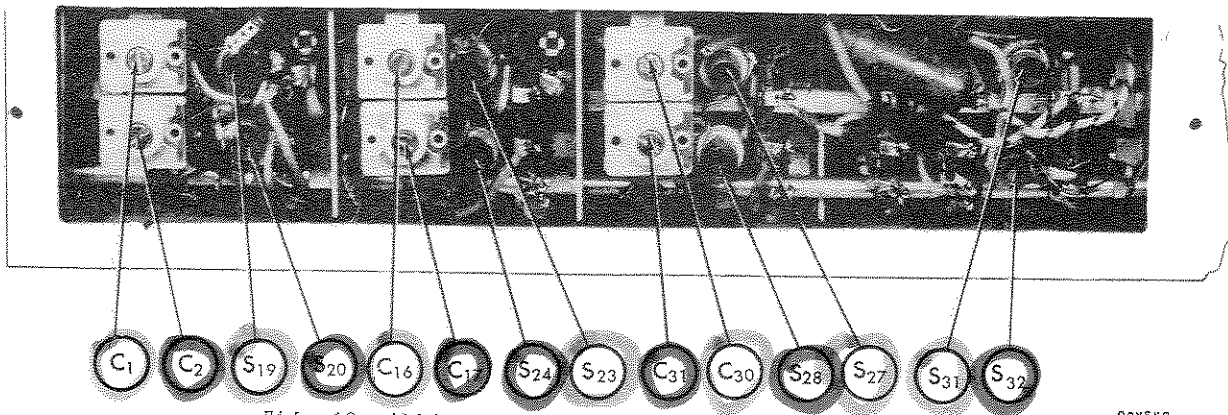

Fig. 10 Alignment adjustments, left side view

92X543

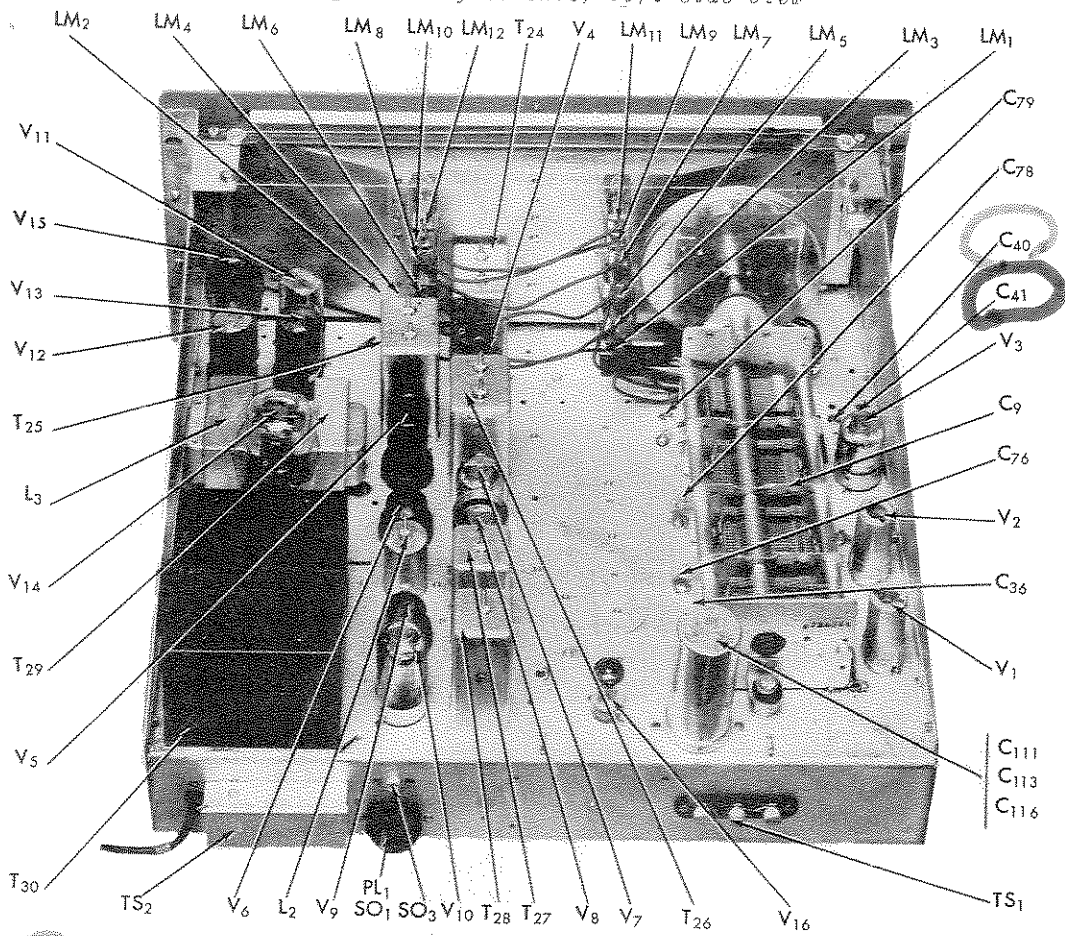

Fig. 11 Component locations, top view

92X544-A

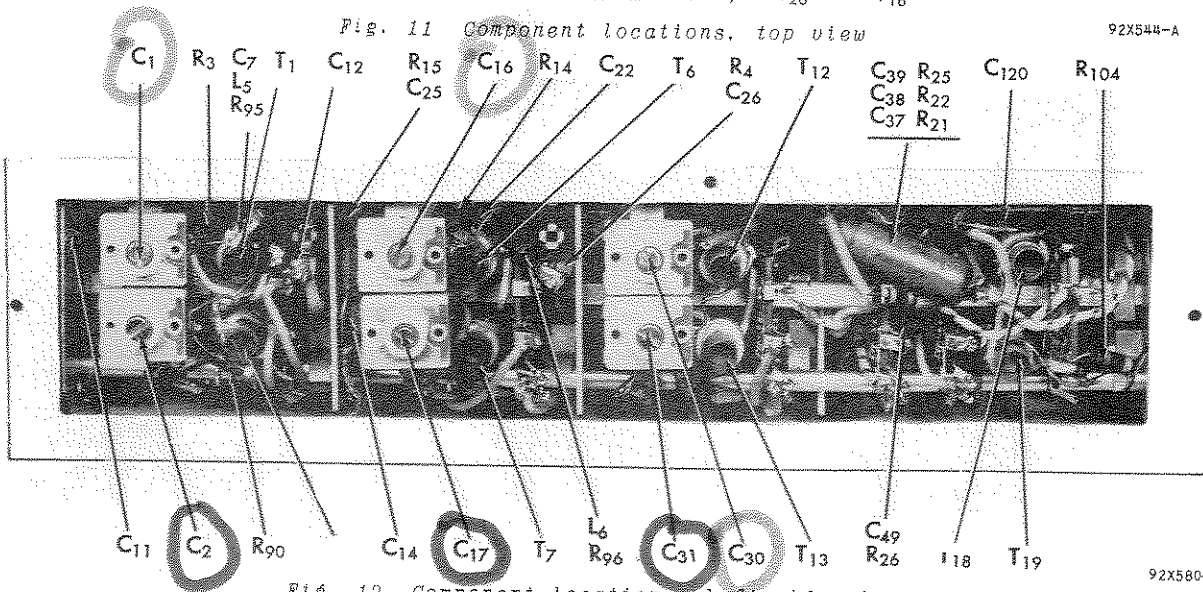
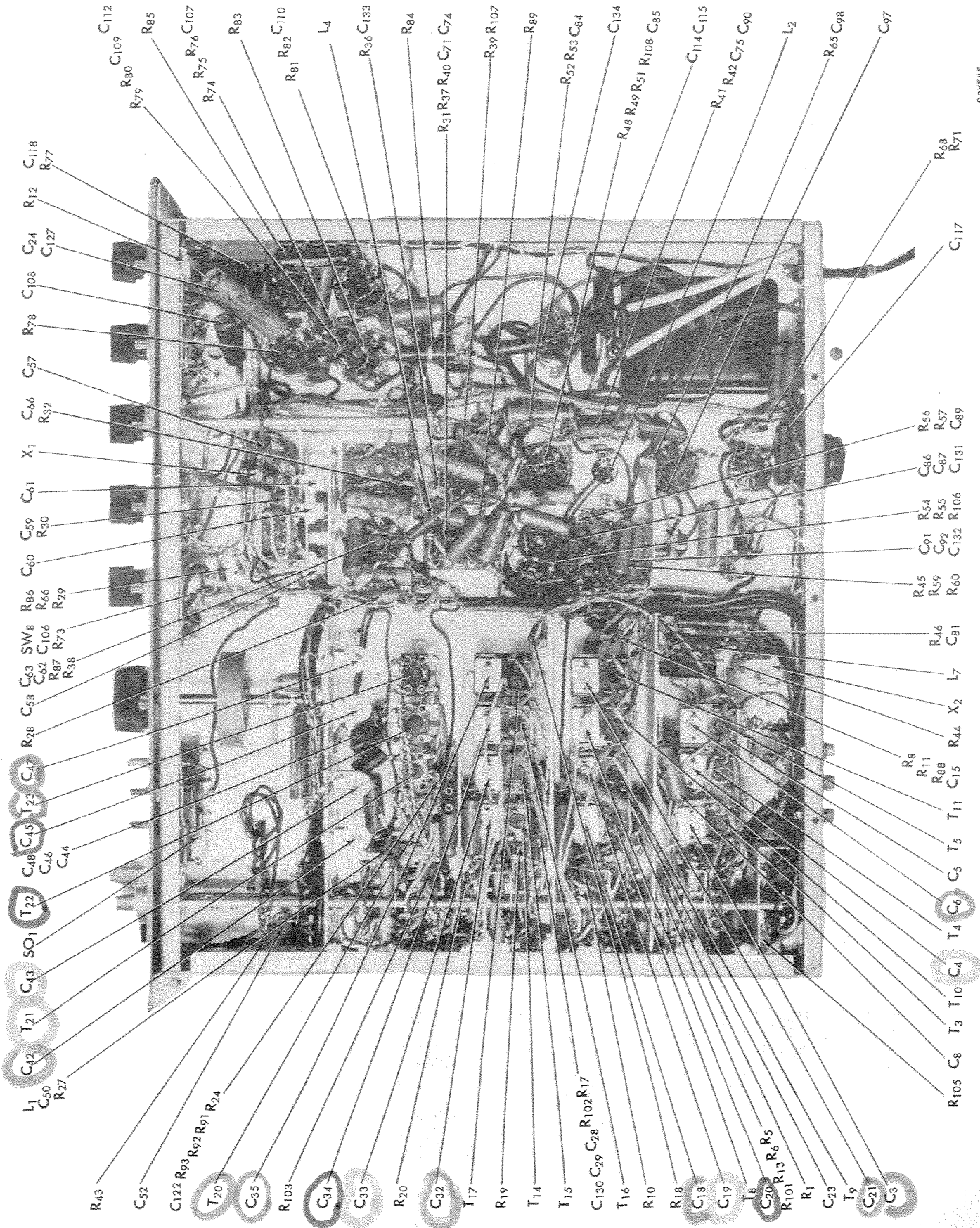

Fig. 12 Component locations, left side view.

92X580-A



92X645

Fig. 13. Component locations, bottom view

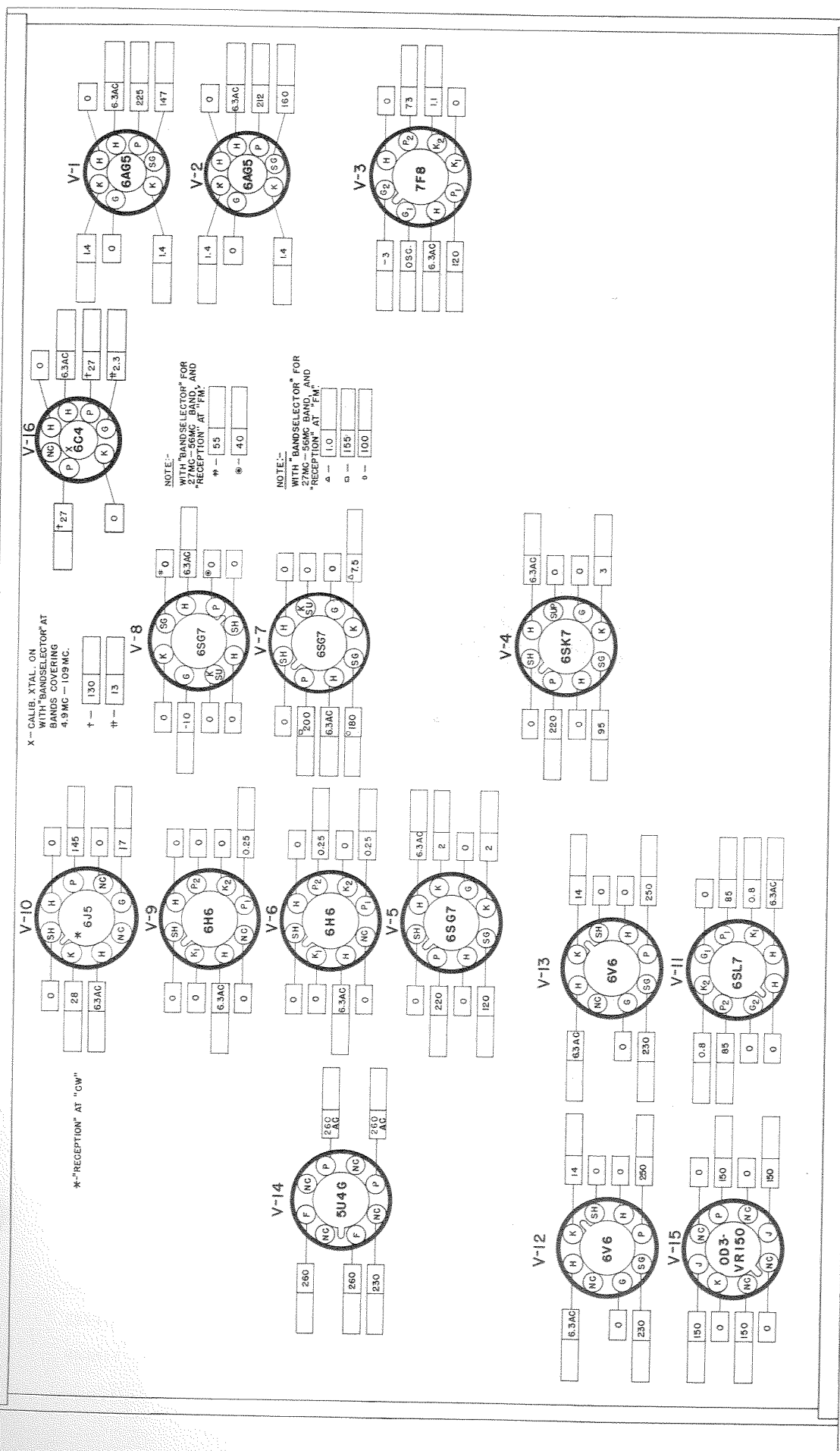

FRONT PANEL NOTES (CONT)

1. SOCKET VIEWS ARE BOTTOM VIEWS.
2. ALL VOLTAGES MEASURED BETWEEN TUBE SOCKET TERMINALS AND GROUND.
3. LINE VOLTAGE - 117 V. AC.
4. ALL VOLTAGES SHOWN ARE DC UNLESS OTHERWISE SPECIFIED.
5. VOLTAGES SHOWN WERE MEASURED WITH A 20,000 OHM/VOLT METER.
6. "NC" - NO CONNECTION.
7. THE BLANK SPACES ARE PROVIDED FOR THE SERVICEMAN. FILL IN THE ACTUAL READING AS TAKEN WITH YOUR OWN EQUIPMENT. A NORMAL OPERATING RADIO SHOULD BE USED FOR THESE MEASUREMENTS.

8. CONTROL SETTING--UNLESS SPECIFIED
 "BAND SELECTOR" AT BAND 1.
 "RECEPTION" AT "AM".
 "CALIB. XTAL" AT "OFF".
 "NOISE LIMITER" AT "OFF".
 "RECEIVE--STANDBY" AT "RECEIVE".
 "SENSITIVITY" AT MAXIMUM GAIN.
 "SELECTIVITY" AT "NORMAL / BOARD".

Fig. 14 Tube socket voltage chart

SERVICE PARTS LIST

Schematic Symbol	Description	Hallcrafters Part Number	Schematic Symbol	Description	Hallcrafters Part Number
CAPACITORS			RESISTORS (Cont.)		
C-1,2,16,17,30,31	Trimmers, adjustable: 2 section; antenna, RF amp, and mixer stages	44B165	R-23	47 ohms 1/2 watt, carbon	23X20X470M
C-3,4,6,18,19,20,21,32,33,34,35	Part of transformers T-3, 4, 5, 8, 9, 10, 11, 14, 15, 16 and 17 respectively	-----	R-24	33 ohms 1/2 watt, carbon	23X20X330M
C-5,129,130	2 mmf. 500 V., bakelite	47A160-4	R-25,75	10,000 ohms 1/2 watt, carbon	23X20X103K
C-7,79	5 mmf. 500 V., ceramic	47X20UK050D	R-26	5600 ohms 1 watt, carbon	23X30X562K
C-8,11,25	.05 mfd. 200 V., tubular	46A091	R-27	470 ohms 1/2 watt, carbon	23X20X471M
C-9	Capacitor, main tuning	48C204	R-28	68,000 ohms 1 watt, carbon	23X30X683K
C-13,15,27,29,50,59,63,74,86,87,91,109,112,132	.02 mfd. 600 V., tubular	46AY203J	R-29	120 ohms 1/2 watt, carbon	23X20X121K
C-14,28	5600 mmf. 500 V., mica	47X35B562M	R-30,42,52	1 megohm 1/2 watt, carbon	23X20X105M
C-22,123	15 mmf. 500 V., ceramic	47X20UK150K	R-31,60	330 ohms 1/2 watt, carbon	23X20X331K
C-23,62,70,84,85	.05 mfd. 200 V., tubular	46AU503J	R-36	1.2 megohms 1/2 watt, carbon	23X20X125K
C-24	.25 mfd. 200 V., tubular	46AT254J	R-37	100,000 ohms 1 watt, carbon	23X30X104K
C-36,76,78,120	7 mmf. 500 V., ceramic	47X20UK070K	R-38	270 ohms 1/2 watt, carbon	23X20X271K
C-37,97	47 mmf. 500 V., mica	47X20B470K	R-39,59,87	56,000 ohms 1/2 watt, carbon	23X20X563K
C-12,26,38,75,81,92,106,117,121,122,131,133,134,135	.01 mfd. 600 V., tubular	46AZ103J	R-41,58,79,80,81,83	220,000 ohms 1/2 watt, carbon	23X20X224K
C-39,49	110 mmf. 500 V., ceramic	47X25UK111J	R-44	4.7 megohms 1/2 watt, carbon	23X20X475K
C-40,41,57	Trimmer, adjustable; oscillator section, bands 5 and 6; crystal phasing	44A078	R-46	27,000 ohms 2 watts, carbon	23X40X273K
C-42	Trimmer, adjustable; oscillator section, band 4	44A347	R-49	330,000 ohms 1/2 watt, carbon	23X20X334K
C-43,45	Trimmer, adjustable; oscillator section, bands 2 and 3	44A047	R-50	1800 ohms 1/2 watt, carbon	23X20X182K
C-44	4700 mmf. 2% 500 V., silver mica	47X35C472G	R-55	10,000 ohms 1 watt, carbon	23X30X103K
C-46	1500 mmf. 2% 500 V., silver mica	47X30C152G	R-56,57,71,94	47,000 ohms 1/2 watt, carbon	23X20X473K
C-47	Trimmer, adjustable; oscillator section band 1	44A076	R-65	150,000 ohms 1/2 watt, carbon	23X20X154K
C-48	470 mmf. 2% 500 V., mica	47X20D471G	R-66	1.5 megohms 1/2 watt, carbon	23X20X155K
C-51	220 mmf. 2% 500 V., mica	47X25E221G	R-68	5100 ohms 5% 1/2 watt, carbon	23X20X512J
C-52,66,71,99,108,118	.05 mfd. 600 V., tubular	46AY503J	R-73	Resistor, variable; VOLUME control	25A549
C-58,60,61	Trimmer, adjustable; crystal phasing	44B164	R-76,92	56 ohms 1/2 watt, carbon	23X20X560K
C-89,90	180 mmf. 500 V., mica	47X20B181K	R-77	1000 ohms 2 watts, carbon	23X40X102K
C-98	560 mmf. 500 V., mica	47X25B561K	R-82	8200 ohms 1/2 watt, carbon	23X20X822K
C-107	10 mfd. 25 V., electrolytic	45A121	R-84	220 ohms 2 watts, carbon	23X40X221K
C-110	680 mmf. 500 V., mica	47X25B681K	R-85	2000 ohms 10 watts, WW	24BG202D
C-111,113,116	20 mfd. 25 V., 30-20 mfd. 450 V. electrolytic	45A041	R-88	2.2 megohms 1/2 watt, carbon	23X20X225K
C-114,115	.01 mfd. 600 V., molded paper	46BR103J6	R-89	68,000 ohms 1/2 watt, carbon	23X20X683K
C-127	100 mfd. 25 V., electrolytic	45A116	R-91,93	4700 ohms 1/2 watt, carbon	23X20X472K
R-1,10,51	100,000 ohms 1/2 watt, carbon	23X20X104M	R-101,102	330 ohms 1/2 watt, carbon	23X20X331M
R-2	12 ohms 1/2 watt, carbon	23X20X120K	R-105	100 ohms 1/2 watt, carbon	23X20X101K
R-3,15	150 ohms 1/2 watt, carbon	23X20X151K	R-108	6.8 ohms 1 watt, carbon	23X30X068K
R-4,54	47,000 ohms 1 watt, carbon	23X30X473K	TRANSFORMERS AND COILS		
R-5,9,14,19,90,103,104	15 ohms 1/2 watt, carbon	23C20X150M	T-1	Transformer, antenna stage; band 6	51B829
R-6,13,17,20	2200 ohms 1/2 watt, carbon	23X20X222M	T-2	Transformer, antenna stage; band 5	51B828
R-7,18,40,67,74,78	1200 ohms 1/2 watt, carbon	23X20X122K	T-3	Transformer, antenna stage; band 4	51B990
R-8,43,53	470,000 ohms 1/2 watt, carbon	23X20X474M	T-4	Transformer, antenna stage; band 3	51B826
R-12	Resistor, variable; SENSITIVITY control	25A548	T-5	Transformer, antenna stage; band 1	51B823
R-16,22,32,45,86,106	1000 ohms 1/2 watt, carbon	23X20X102M	T-6	Transformer, RF stage; band 6	51B833
R-21,48,107	2.2 megohms 1/2 watt, carbon	23X20X225M	T-7	Transformer, RF stage; band 5	51B832
			T-8	Transformer, RF stage; band 4	51B989
			T-9	Transformer, RF stage; band 3	51B987
			T-10	Transformer, antenna stage; band 2	51B825
			T-11	Transformer, RF stage; band 1	51B824
			T-12	Transformer, mixer stage; band 6	51B833
			T-13	Transformer, mixer stage; band 5	51B844
			T-14	Transformer, mixer stage; band 4	51B989
			T-15	Transformer, mixer stage; band 3	51B988
			T-16	Transformer, mixer stage; band 2	51B986

SERVICE PARTS LIST (Cont.)

Schematic Symbol	Description	Hallicrafters Part Number	Schematic Symbol	Description	Hallicrafters Part Number
TRANSFORMERS AND COILS (Cont.)			TUBES, RECTIFIERS AND LAMPS		
T-17	Transformer, mixer stage; band 1	51B985	V-1,2	Type 6AG5, 1st & 2nd RF amplifiers	90X6AG5
T-18	Transformer, oscillator stage; band 6	51B839	V-3	Type 7F8, oscillator/mixer	90X7F8
T-19	Transformer, oscillator stage; band 5	51B838	V-4	Type 6SK7, 1st IF amplifier	90X6SK7
T-20	Transformer, oscillator stage; band 4	51B991	V-5	Type 6SG7, 2nd IF amplifier	90X6SG7
T-21	Transformer, oscillator stage; band 3	51B836	V-6,9	Type 6H6, noise limiter & discriminator	90X6H6
T-22	Transformer, oscillator stage; band 2	51B835	V-7,8	Type 6SG7, 3rd IF amplifier & AM detector	90X6SG7
T-23	Transformer, oscillator stage; band 1	51B834	V-10	Type 6J5, BFO	90X6J5
T-24	Transformer, 1st IF amp. stage	50C198	V-11	Type 6SL7GT, phase inverter	90X6SL7GT
T-25	Transformer, 2nd IF amp. stage	50C190	V-12,13	Type 6V6GT, AF power amplifier	90X6V6GT
T-26	Transformer, 3rd IF amp. stage	50C373	V-14	Type 5U4G, rectifier	90X5U4G
T-27	Transformer, FM detector	50C191	V-15	Type OD3/VR150, voltage regulator	90XVR150
T-28	Transformer, BFO	54C032	V-16	Type 6C4, calibration oscillator	90X6C4
T-29	Transformer, audio output	55B077	LM-1,2,3,4,5,	Lamp, pilot; 6-8 V., Mazda #44 (blue bead)	39A003
T-30	Transformer, power; 115 V. 50/60 cycles (Model SX-62)	52C141	6,7,8,9,10, 11,12		
T-30	Transformer, power; 115/230 V. 25/60 cycles (Model SX-62U)	52C131			
SWITCHES			MISCELLANEOUS		
L-1	RF choke (coded red)	53B008		Clip, dial scale & window mtg.	76A403
L-2	IF coupling coil	53B104	X-1	Crystal, 455 KC	19A125
L-3	Choke, filter	56B067	X-2	Crystal, calibration; 500 KC	19A1211
L-4	RF choke; filament	53A009		Dial cord, dial drive	38A017
L-5,6	RF choke; screen (wound on R-95 & R-96)	53A117		Dial cord, pointer index	38A026
L-7	RF choke; plate	53A139		Dial pointer	82C203
				Dial scale (calibrated)	22D215
				Escutcheon	7D078
				Flywheel, dial drive	71A178
SW-1	Switch, BAND SELECTOR	60B329		Knob, BAND SELECTOR	15A419
SW-2	Switch, SELECTIVITY	60A234		Knob, TUNING	15A048
SW-3	Switch, RECEPTION	60C330		Knob, POINTER RESET	15A074-1
SW-4	Switch, TONE	60C236		Knob, RECEPTION, SELECTIVITY, TONE, VOLUME & SENSITIVITY control	15A046
SW-5,6,7	Switch, toggle; SPST	60A138			
SW-8	Switch, power (part of volume control R-73)	-----			
PLUGS AND SOCKETS					
PL-1	Plug, JUMPER (for AC operation)	35A003		Lock, line cord; male section	76A397-1
PL-2	Plug and cord, power	87A078		Lock, line cord; female section	76A397-2
SO-1	Socket, octal; BATTERY POWER	6A035		Mounting foot; rubber	16A029
SO-2	Jack, PHONES	36B030		Pulley, drive	28B068
SO-3	Jack, PHONO	36A041		Screw, knurled head; for TS-1 and TS-2	3A1371
	Socket, dial lamp	86B073-1		Shaft, general coverage dial	74A252
	Socket, octal; black molded	6B296		Shaft, index control	74A013
	Socket, loktal; mica	6A223		Spring, dial drive	75A232
	Socket, miniature 7 pin; mica	6A268		Spring, pointer index	75A232
	Socket, miniature 7 pin; molded bakelite	6A292		Terminal strip, antenna or speaker	88A567
	Socket, octal	6A035		Washer, "C" type; index control shaft	4A333
				Window, dial	22C214

Microcrafters
Part Number

20X470M
20X330M
20X103K
30X562K
20X471M
30X683K
20X121K
20X105M
20X331K
20X125K
30X104K
20X271K
30X563
20X224K

20X475K
20X273K
20X334K
20X103K
20X473K
20X154K
20X155K
20X512J

20X560K
20X102K
20X822K
20X21K
20D
20X25K
20X683K
20X472K
20X331M
20X101K
20X688K

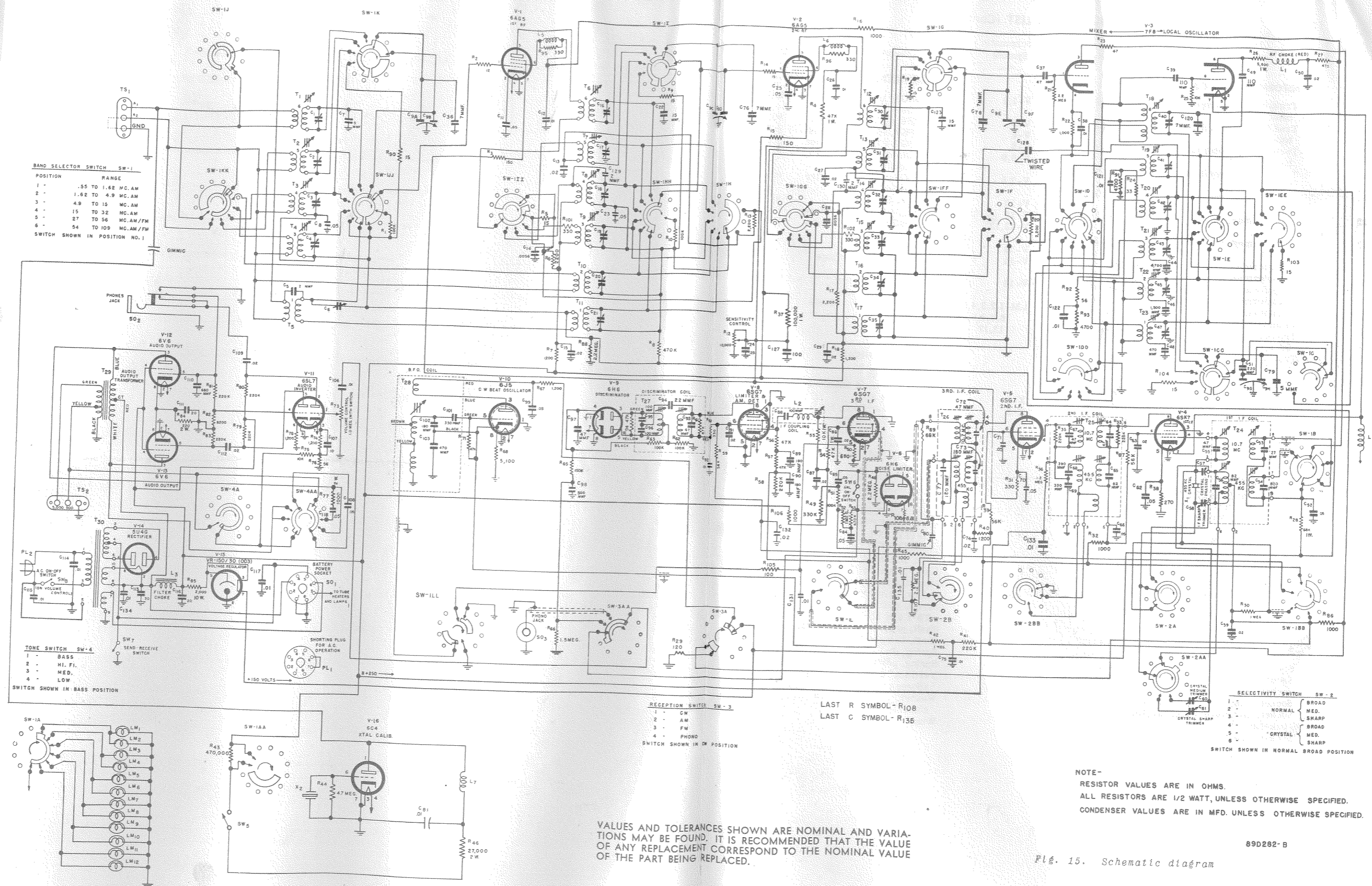

NOTE-
RESISTOR VALUES ARE IN OHMS.
ALL RESISTORS ARE 1/2 WATT, UNLESS OTHERWISE SPECIFIED.
CONDENSER VALUES ARE IN MFD. UNLESS OTHERWISE SPECIFIED.

89D282-B

Fig. 15. Schematic diagram