

K1 BOX

**OPERATING
ALIGNMENT & SERVICING
INSTRUCTIONS FOR
SUPER SKYRIDER
Models S-17 SX-17**

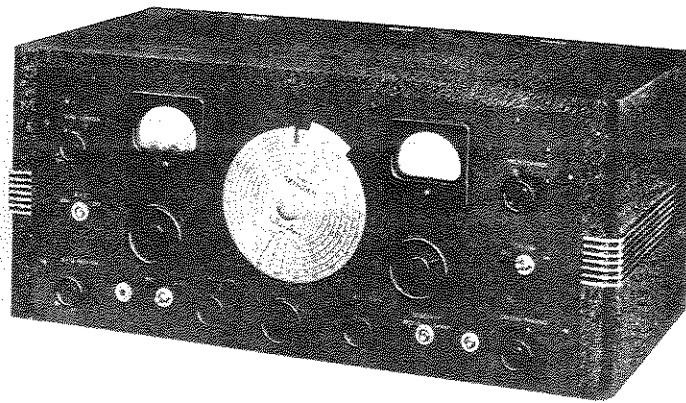

the hallicrafters *co.*

CHICAGO

94X1743

OPERATING INSTRUCTIONS - SPECIAL SUPER-SKYRIDER MODELS S-17, SX-17

THE SPECIAL SUPER-SKYRIDER IS A 6 BAND 13 TUBE SUPERHETERODYNE RECEIVER COVERING THE FOLLOWING FREQUENCIES:

BANDS	COVERAGE
1	545 KC TO 1,555 KC
2	1,545 KC TO 4,300 KC
3	4.2 MC TO 10.2 MC
4	9.8 MC TO 20.5 MC
5	19.00 MC TO 36.00 MC
6	35.00 MC TO 62.00 MC

SEPARATE COILS ARE USED TO COVER EACH BAND. INDUCTIVE COUPLING TO THE ANTENNA PERMITS THE MAXIMUM TRANSFER OF SIGNAL ENERGY FROM EACH SEPARATE PRIMARY TO THE PARTICULAR SECONDARY COIL IN THE CIRCUIT. THE UNUSED COILS ARE SHORTED.

THE COIL RANGE IN USE IS INDICATED BY THE POINTER IN FRONT OF THE MAIN DIAL. THIS POINTER MOVES VERTICALLY WHEN CHANGING BANDS. THE MAIN DIAL IS CALIBRATED IN KILOCYCLES ON BANDS NO. 1 AND 2 AND IN MEGACYCLES ON THE REMAINING FOUR BANDS. THE CALIBRATION ON THE MAIN DIAL WILL HOLD ACCURACY ONLY WHEN THE BAND SPREAD DIAL READS "0", OR THE POSITION AT WHICH MINIMUM CAPACITY IS INDICATED.

ANTENNA

IN THE BACK CENTER OF THE CHASSIS WILL BE FOUND THE INSULATED ANTENNA AND DOUBLET BINDING POSTS. IF A DOUBLET ANTENNA IS USED, REMOVE THE JUMPER FROM THE ONE INSULATED POST TO THE CHASSIS AND CONNECT THE TWO WIRES FROM THE DOUBLET TO THE INSULATED POSTS. PLEASE REMEMBER THAT THE REGULAR SHORT WAVE DOUBLET IS DESIGNED TO WORK BEST ON THE SHORT WAVE BROADCAST FREQUENCIES THIS MEANS THAT IT WILL NOT PERFORM EQUALLY WELL ON THE AMATEUR BANDS OR FREQUENCIES IN BETWEEN THE SHORT WAVE BROADCAST CHANNELS. WHEN USING THE CONVENTIONAL FLAT-TOP AND LEAD-IN TYPE OF ANTENNA CONNECT THE LEAD-IN TO THE INSULATED POST FARTHEST TO THE LEFT, BEING SURE THAT THE WIRE JUMPER IS CONNECTED TO THE CHASSIS AND THE OTHER INSULATED POST. ANTENNA SHOULD BE LOCATED IN THE CLEAR OF SURROUNDING OBJECTS. LENGTH AND TYPE OF ANTENNA PLAY A MOST IMPORTANT PART IN THE SUCCESSFUL OPERATION OF THE SET, ON THE HIGHER FREQUENCIES ESPECIALLY. ON THE 5TH AND 6TH BANDS IT IS PARTICULARLY IMPORTANT TO USE THE PROPER ANTENNA. FOR MOST EFFICIENT ANTENNA SYSTEMS YOU ARE REFERRED TO THE ANTENNA DESIGN SECTION OF THE A. R. R. L. HANDBOOK, AS WELL AS CURRENT RADIO PERIODICALS. IT IS SUGGESTED THAT A LITTLE EXPERIMENTING BE DONE WITH ANTENNAE SO THAT YOU WILL EXPERIENCE THE MAXIMUM IN PERFORMANCE FROM YOUR RECEIVER.

OPERATION

PLUG THE CORD ON THE RECEIVER INTO THE POWER SOCKET. (UNLESS OTHERWISE SPECIFIED THE RECEIVER OPERATES ON 60 CYCLE 110 VOLT ALTERNATING CURRENT.) TURN THE CONTROL MARKED "TONE" TO THE RIGHT. THIS WILL TURN

THE RECEIVER ON. DURING THE TIME THE RECEIVER IS WARMING UP ALSO TURN THE "R.F. GAIN" AND "A.F. GAIN" KNOBS TO THE RIGHT. THE RECEIVER IS SHIPPED WITH THE BAND CHANGE SWITCH IN THE HIGHEST FREQUENCY RANGE. ADJUST THE "BANDS" SWITCH UNTIL THE POINTER ON THE CALIBRATED MAIN DIAL INDICATES THE BAND YOU WISH TO TUNE. IT IS SUGGESTED THAT YOU FAMILIARIZE YOURSELF WITH THE OPERATION OF THE RECEIVER ON BANDS No. 1 AND No. 2 BEFORE TRYING THE HIGHER FREQUENCIES. WHEN LISTENING FOR DISTANT OR POSSIBLY WEAK SIGNALS, IT IS RECOMMENDED THAT THE CONTROL MARKED "BFO INJECTION" BE USED BY TURNING THE KNOB TO THE RIGHT. ONCE THESE SIGNALS ARE LOCATED, IT SHOULD BE TURNED OFF OR A CONTINUOUS WHISTLE WILL RESULT. WHEN LISTENING TO C.W. TRANSMISSIONS THE CONTROL MUST BE LEFT ON AND THE STRENGTH OF THE BFO OUTPUT INCREASED AS THE CONTROL IS ADVANCED TO THE RIGHT. THE "PITCH CONTROL" KNOB WILL PROVE MOST HELPFUL IN CHANGING THE BEAT NOTE TO ONE MOST PLEASING THE OPERATOR. WHEN THE BFO CONTROL IS ON THE "AVC" SWITCH SHOULD ALWAYS BE IN THE "OFF" POSITION.

PHONE RECEPTION

WHEN RECEIVING VOICE, WHETHER BROADCAST OR SHORT WAVE, IT IS RECOMMENDED THAT THE "AVC" SWITCH BE LEFT IN THE "ON" POSITION. THE "R.F. GAIN" CONTROL WITH THE "AVC" SWITCH IN THE "ON" POSITION SHOULD BE TURNED AS FAR AS IT WILL GO TO THE RIGHT - OR UNTIL YOU HAVE HEARD THE SNAP SWITCH WORK WHICH IS MOUNTED ON THE REAR OF THIS CONTROL. IT WILL BE NOTICED THAT WITH THE "AVC" SWITCH "OFF" AND THE "R.F. GAIN" WIDE OPEN THE SET WILL BLOCK ON STRONG SIGNALS. WHEN THIS OCCURS THE SENSITIVITY OF THE RECEIVER SHOULD BE ADJUSTED MANUALLY WITH THE "R.F. GAIN" CONTROL TO A POINT BELOW WHICH THE OVERLOADING OCCURS. BY OPTIONALLY ADJUSTING BOTH THE "R.F. GAIN" AND "A.F. GAIN" CONTROLS YOU WILL FIND THE MOST FAVORABLE RATIO OF SIGNAL TO NOISE. THE "CARRIER LEVEL" METER WILL FUNCTION ONLY WHEN THE "AVC" SWITCH IS "ON" AND THE "R.F. GAIN" CONTROL IS ADVANCED TO THE RIGHT UNTIL THE SWITCH WHICH IS MOUNTED ON THE BACK OF THIS CONTROL IS HEARD BEING CLOSED.

ON THE BACK OF THE CHASSIS IS THE ADJUSTMENT CONTROL FOR PROPERLY SETTING THE CARRIER LEVEL METER. WITH THE AVC SWITCH IN THE ON POSITION, AND THE R.F. GAIN WIDE OPEN THE CONTROL SHOULD BE ADJUSTED SO THAT THE METER WILL READ "0". THE ANTENNA SHOULD BE DISCONNECTED FOR THIS OPERATION AND THE RECEIVER DETUNED FROM ANY SIGNAL THAT MIGHT BE AUDIBLE UNDER THAT CONDITION.

C. W. OPERATION

FOR THE RECEPTION OF C. W. SIGNALS, THE "AVC" SWITCH SHOULD BE IN THE "OFF" POSITION AND THE "BFO INJECTION" CONTROL TURNED ON. VARIATION OF THIS CONTROL CHANGES THE OUTPUT OF THE BEAT OSCILLATOR. WEAK SIGNALS WHICH WOULD NORMALLY BE INAUDIBLE WITH A STRONG BEAT OSCILLATOR ARE EASILY COPIED BY ADJUSTING THE INJECTION CONTROL FOR MINIMUM OUTPUT. TURNING THE CONTROL TO THE RIGHT AS FAR AS IT WILL GO GIVES MAXIMUM BEAT OSCILLATOR OUTPUT. WHEN SO ADJUSTED THE OSCILLATOR WILL HAVE SUFFICIENT ENERGY TO COMPLETELY BEAT THE MOST POWERFUL OF INCOMING SIGNALS.

THE TUBE LINE-UP

6K7 1ST STAGE OF R. F.
6K7 2ND STAGE OF R. F.
6L7 1ST DETECTOR-MIXER
6J5 SIGNAL FREQUENCY OSCILLATOR
6K7 1ST I. F. AMPLIFIER
6K7 2ND I. F. AMPLIFIER
6R7 2ND DETECTOR, AVC, 1ST STAGE OF AUDIO
2-6V6 PUSH-PULL SECOND STAGE OF AUDIO
6J7 BEAT FREQUENCY OSCILLATOR
6J7 "S" METER AMPLIFIER
6H6 NOISE SILENCER
5Z3 FULL-WAVE RECTIFIER

THE TWO STAGES OF RADIO FREQUENCY AMPLIFICATION PROVIDE MAXIMUM GAIN IN INVERSE RELATION TO FREQUENCY. THE TWO STAGES OF R. F. ALSO GIVE CONSIDERABLY GREATER SELECTIVITY AS WELL AS A MORE FAVORABLE RATIO OF SIGNAL TO IMAGE.

THE OUTPUT FROM THE 6J5 SIGNAL FREQUENCY OSCILLATOR IS ELECTRON COUPLED TO THE INJECTOR, OR NO. 3 GRID, OF THE 6L7 1ST DETECTOR-MIXER. BECAUSE NO OSCILLATOR PLATE CURRENT FLOWS IN THE 1ST DETECTOR, THE RATIO OF SIGNAL TO NOISE IS MORE FAVORABLE THAN THAT OBTAINED IN A COMPOSITE TUBE, OR IN CIRCUITS WHERE THE CATHODES OF TWO TUBES ARE TIED TOGETHER.

THE 6J5 OSCILLATOR HAS SEPARATE COILS FOR EACH BAND. SUPERIOR OVERALL PERFORMANCE OF THE SPECIAL SUPER-SKYRIDER IS IN PART DUE TO THE DESIGN OF THE SIGNAL FREQUENCY OSCILLATOR. NO HARMONICS OF THE OSCILLATOR ARE USED ON ANY OF THE BANDS.

THE TWO 6K7 I. F. AMPLIFIER STAGES USE IRON-CORE TRANSFORMERS WHICH RESONATE AT 465 KC. THIS TYPE OF TRANSFORMER HAS SO DEFINITELY DEMONSTRATED ITS SUPERIORITY OVER THE AIR CORE TYPE AS TO WARRANT ITS USE IN THE SPECIAL SUPER-SKYRIDER. TREMENDOUS GAIN AND A BETTER SIGNAL TO NOISE RATIO ARE BUT TWO OF THE MANY ADVANTAGES OF THE IRON-CORE SYSTEM.

THE 6R7 SECOND DETECTOR GIVES HALF-WAVE DIODE DETECTION, AVC, AND THE TRIODE SECTION OF THIS TUBE IS THE FIRST STAGE OF AUDIO AMPLIFICATION. THE PLATE OF THIS SECTION OF THIS MULTI-PURPOSE TUBE IS TRANSFORMER COUPLED TO THE GRIDS OF THE PUSH-PULL 6V6'S.

THE PUSH-PULL 6V6 STAGE RUNNING STRAIGHT CLASS "A" DELIVERS 13 WATTS OF UNDISTORTED AUDIO POWER. BEFORE ACTUALLY DRAWING ANY GRID CURRENT THE OUTPUT IS IN THE NEIGHBORHOOD OF 18 WATTS.

THE BEAT OSCILLATOR 6J7 IS ELECTRON COUPLED TO THE DIODE SECTION OF THE 6R7 SECOND DETECTOR.

THE 6J5 NOISE SILENCER IS IN THE AUDIO END OF THE RECEIVER. IT IS PARTICULARLY EFFECTIVE IN LIMITING INTERMITTENT, PULSATING TYPES OF INTERFERENCE AND THROUGH ITS USE HEARING A SIGNAL THAT WOULD BE USUALLY LOST IN THE NOISE.

THE HIGH-CURRENT 5Z3 RECTIFIER PROVIDES AMPLE CURRENT FOR THE COMPLETE RECEIVER WITH ITS PUSH-PULL 6V6 AUDIO OUTPUT STAGE.

I. F. AMPLIFIER

ALL INTERMEDIATE FREQUENCY TRANSFORMERS ARE OF THE IRON CORE TYPE AND RESONATE AT 465 KC. THE I. F. AMPLIFYING SYSTEM OF THE SPECIAL SUPER-SKYRIDER IS OF THE EXPANDING TYPE PROVIDING A WIDTH EXPANDED OF 18 KCS AT 100 X RESONANT INPUT. BECAUSE OF THIS FEATURE IT IS CONVENIENT TO USE THE RECEIVER IN THE BROAD POSITION WHEN COVERING THE BAND AND LOOKING FOR A CALL. ONCE LOCATED THE DESIRED STATION CAN THEN BE SHARPENED BY SWITCHING TO THE "SHARP" POSITION. FIDELITY OF BROADCAST RECEPTION IS MATERIALLY IMPROVED WITH THE I. F. AMPLIFIER IN THE "BROAD" POSITION.

CRYSTAL OPERATION

TO PROPERLY ADJUST THE CRYSTAL CIRCUIT FOR BEST PERFORMANCE THE FOLLOWING PROCEDURE SHOULD BE CAREFULLY FOLLOWED:

HAVE THE AVC SWITCH IN THE "OFF" POSITION. TUNE IN SOME STATION TRANSMITTING CONTINUOUSLY. BE VERY CAREFUL TO GET THE SIGNAL RIGHT ON THE NOSE. AFTER YOU ARE SURE THAT YOU HAVE THE SIGNAL RESONATED PERFECTLY, OPERATE THE "BFO INJECTOR" CONTROL AND LEAVE THE POINTER OF THAT KNOB IN A VERTICAL POSITION. YOU SHOULD HEAR A WHISTLE, OR BEAT NOTE. AFTER THE BFO IS ON ROTATION OF THE "PITCH CONTROL" WILL CHANGE THE TONE OF THE BEAT NOTE. PROPER OPERATION OF THIS CONTROL WILL BE INDICATED BY HEARING THE SIGNAL TWICE IN ONE COMPLETE ROTATION OF THE KNOB; THERE BEING TWO POSITIONS AT WHICH NO SIGNAL, OR WHISTLE, WILL BE HEARD. THESE TWO POSITIONS ARE KNOWN AS THE "ZERO BEAT" POSITIONS.

NOW SNAP THE "CRYSTAL" SWITCH TO THE "ON" POSITION. YOU WILL NOTICE A REDUCTION IN NOISE. CAREFULLY RETUNE THE SIGNAL USING THE BAND SPREAD DIAL. NOTICE HOW SHARPLY THE SIGNAL PEAKS. NOW TUNE THROUGH THE SIGNAL AND FIND WHICH SIDE OF THE SIGNAL IS THE WEAKER. TUNE IN THE WEAKER SIDE AND THEN CAREFULLY ADJUST THE "CRYSTAL PHASING" CONTROL UNTIL THE SIGNAL IS INAUDIBLE. GOING BACK TO THE OTHER SIDE OF THE SIGNAL SHOULD FIND NO CHANGE IN ITS ORIGINAL VOLUME, AND KNIFE-LIKE SELECTIVITY RESULTING. USE WHICHEVER SIDE OF ZERO-BEAT ADJUSTMENT OF THE "PITCH CONTROL", IN CONJUNCTION WITH CRITICAL ADJUSTMENT OF THE "PHASING CONTROL" GIVES THE GREATER REJECTION OF THE INTERFERING SIGNAL.

NOTE*** THE PHASING CONTROL AFFECTS THE SENSITIVITY AND SELECTIVITY OF THE RECEIVER WHETHER THE CRYSTAL IS IN THE CIRCUIT OR NOT.

SPEAKER - HEADPHONES ETC.

ON THE LOWER RIGHT HAND CORNER ON THE BACK OF THE CHASSIS YOU WILL FIND A TERMINAL STRIP MARKED 5000 OHMS. TO THIS STRIP CONNECT THE PERMANENT MAGNET DYNAMIC SPEAKER. TO THE TERMINAL STRIP MARKED 500 OHMS CAN BE CONNECTED A LOAD OF THAT VALUE OF IMPEDANCE. THE OTHER TERMINAL STRIP TO THE RIGHT OF THESE TWO, AND MARKED "EXT SW", IS USED TO MAKE THE RECEIVER TEMPORARILY INOPERATIVE FOR STAND-BY DURING PERIODS OF TRANSMITTING. THESE TWO TERMINALS SHOULD BE CONNECTED TO AN EXTERNAL SWITCH WHETHER IN CONJUNCTION WITH THE POWER SWITCH ON YOUR TRANSMITTER OR A MANUALLY OPERATED SWITCH AT YOUR OPERATING POSITION. WHEN USING AN EXTERNAL SWITCH THE "SEND RECEIVE" SWITCH ON THE FRONT OF THE RECEIVER SHOULD BE IN THE SEND POSITION.

IN THIS RECEIVER THE SPEAKER IS NOT A PORTION OF THE FILTER SYSTEM. THIS ALLOWS THE RECEIVER TO BE OPERATED INDEPENDENTLY OF THE SPEAKER. FOR MOST SATISFACTORY RESULTS A 12 INCH HALLICRAFTERS MATCHING SPEAKER SHOULD BE USED WITH THE SPECIAL SUPER-SKYRIDER.

THE HEADPHONE JACK IS CONNECTED TO ONE OF THE 6V6 TUBE GRIDS. THE POSSIBILITY OF SHOCK TO THE OPERATOR IS ELIMINATED BY HAVING NO DIRECT CURRENT FLOWING THROUGH THE HEADPHONES. CRYSTAL TYPE HEADPHONES CAN BE USED WITH THIS RECEIVER WITHOUT USING A SPECIAL COUPLING TRANSFORMER.

USING THE VERNIER SCALE

BY MEANS OF THE VERNIER SCALE, THE MAIN DIAL MAY BE READ AND RESET TO ONE-TENTH OF A DIVISION WITH AN ACCURACY OF ONE PART IN TWO THOUSANDS. THE THREE PICTURES BELOW ILLUSTRATE THE CORRECT READINGS FOR THREE TYPICAL SETTINGS. THE FRACTION OF THE WHOLE NUMBER IS ALWAYS THAT DIVISION ON THE VERNIER SCALE WHICH LINES UP WITH A DIVISION ON THE MAIN DIAL. TAKE FOR EXAMPLE THE FIRST ILLUSTRATION:

THE ZERO ON THE VERNIER SCALE INDICATOR FALLS BETWEEN 169 AND 170, SO THE WHOLE NUMBER WILL BE 169 AND THE FRACTION WILL BE FOUND BY GLANCING ALONG THE VERNIER SCALE UNTIL A DIVISION ON IT LINES UP WITH ONE ON THE MAIN DIAL. IN THIS CASE IT IS 7 SO THE CORRECT READING IS 169 PLUS 0.7 OR 169.7.

THE NUMBER 170 IN THE MIDDLE ILLUSTRATION FALLS EXACTLY UNDER THE ZERO INDICATOR AND THE PROOF OF THIS IS THAT 10 ON THE VERNIER SCALE IS THE ONLY DIVISION WHICH LINES UP WITH A DIVISION ON THE MAIN DIAL. ACTUALLY THE CORRECT READING IS 169 PLUS 1.0 OR 170 AND NOT 170 PLUS 1.0

THE THIRD ILLUSTRATION SHOWS THE CORRECT READING FOR 170.3 DIVISIONS.

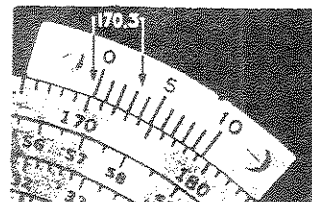
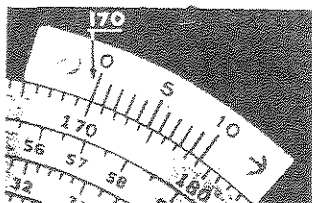
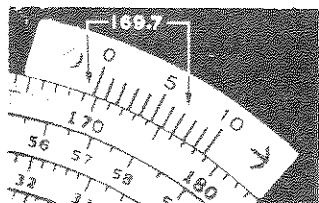

ALIGNMENT PROCEDURE FOR SPECIAL SUPER SKYRIDER MODELS S-17, SX17

THE FOLLOWING MEASUREMENTS MADE WITH 1000 OHMS PER VOLT METER AND TAKEN FROM THE POINT INDICATED TO GROUND. ANTENNA AND GROUND DISCONNECTED AND R. F. AND A. F. GAIN CONTROLS SET AT MAXIMUM. LINE VOLTAGE OF 115 AT THE TIME MEASUREMENTS WERE TAKEN. NORMAL TOLERANCE ALLOWS VARIATION OF PLUS OR MINUS 10% FROM THE INDICATED VALUES. "DL" MEANS DEAD LUG BUT WILL INDICATE VOLTAGE WHEN USED AS A TIE.

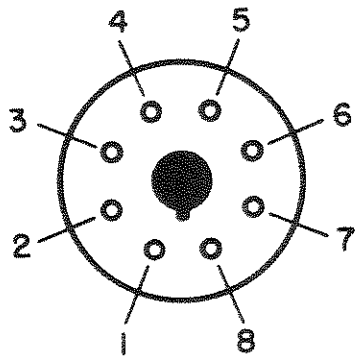

BOTTOM VIEW OF SOCKET

TUBE	FUNCTION	1	2	3	4	5	6	7	8
6K7	RF AMP (1)			260	100	8	0 ON 50 OFF	6.3	8
6K7	RF AMP (2)			260	100	8	0 ON 50 OFF	6.3	8
6L7	MIXER			260	85	-13	DL	6.3	2.5
6J5G	Osc			175	DL	-13	DL	6.3	0
6K7	IF AMP (1)			260	100	11	100	6.3	10
6K7	IF AMP (2)			260	100	10	.5 ON 50 OFF	6.3	10
6R7G	2ND DET A.V.C.			175	1	1	0	6.3	-7
6V6G	1ST AUDIO OUTPUT			300	250	0	DL	6.3	16
6V6G	OUTPUT			300	250	0	DL	6.3	16
6J7	BEAT Osc.	(TUBE OUT)		250	240	0	DL 260	6.3	0
6J7G	METER AMP			260	120	10	250	6.3	10
6H6	SILENCER	(ON)		-2	-2	-2		6.3	-2

INTERMEDIATE FREQUENCY ALIGNMENT (465 KC)

HAVE THE CONTROLS SET IN THE FOLLOWING POSITIONS:

- NOISE SILENCER "OFF" (SWITCH TO THE LEFT)
- B.F.O. INJECTOR "OFF"
- A.F. AND R.F. GAIN CONTROLS ON FULL.
- SELECTIVITY SWITCH ON "SHARP" POSITION.
- CRYSTAL PHASING CONDENSER MIDWAY (POINTER STRAIGHT UP).
- A.V.C. SWITCH "OFF".
- CRYSTAL SWITCH "IN".

(I. F. ALIGNMENT CONTINUES)

BAND SWITCH ON #1 BAND - TUNING GANG OPEN.

REMOVE OSCILLATOR TUBE.

REMOVE 6L7 GRID CAP.

CONNECT SIGNAL GENERATOR TO GRID OF 6L7 TUBE THROUGH A .1 MFD CONDENSER. TUNE SIGNAL GENERATOR TO 465 KC AND THEN ADJUST THE FOLLOWING TRIMMERS FOR MAXIMUM OUTPUT: T-4#7,8; T3-#5,6; T2-#3,4; T1-#1,2; THROW CRYSTAL SWITCH TO OUT POSITION AND READJUST TRIMMERS #2, 3 FOR MAXIMUM OUTPUT. WHEN THE "SELECTIVITY" SWITCH IS SNAPPED INTO THE "BROAD" POSITION A SLIGHT DROP IN GAIN SHOULD BE INDICATED. A RECTIFIER TYPE OUTPUT METER IS SUGGESTED AS AN OUTPUT INDICATOR.

ALIGNMENT USING A 465 KC CRYSTAL

SHOULD THE RECEIVER BE A CRYSTAL MODEL IT IS NECESSARY THAT THE CRYSTAL BE USED IN AN EXTERNAL OSCILLATOR IN PLACE OF A SIGNAL GENERATOR SUCH AS THE ABOVE. THE OUTPUT OF THIS CRYSTAL-CONTROLLED OSCILLATOR IS THEN FED TO THE GRID OF THE 6L7 TUBE AND THE ABOVE PROCEDURE FOLLOWED. WHEN THE I F AMPLIFIER HAS BEEN ALIGNED FROM THE CRYSTAL OSCILLATORS OUTPUT, RE-INSERTING THE CRYSTAL IN THE RECEIVER WILL SHOW VERY LITTLE DIFFERENCE IN OUTPUT WHETHER THE CRYSTAL IS "IN" OR "OUT" OF THE CIRCUIT AS INDICATED BY THE CRYSTAL SWITCH.

R. F. ALIGNMENT PROCEDURE

ON BAND #1, OR BROADCAST, USE A .0002 MFD CONDENSER IN SERIES WITH THE OUTPUT LEAD FROM GENERATOR TO RECEIVER. ON THE OTHER BANDS USE A 400 OHM RESISTOR. BE SURE JUMPER FROM DOUBLET POST TO GND. REMAINS CONNECTED WHEN ALIGNING THE RECEIVER.

ALL PAD ADJUSTMENTS (LOCATED ON THE TOP OF THE CHASSIS) ARE FOR THE LOW FREQUENCY ENDS OF THE BANDS.

ALL TRIMMER ADJUSTMENTS (LOCATED ON THE BOTTOM OF THE CHASSIS) ARE FOR THE HIGH FREQUENCY ENDS OF THE BANDS.

REDUCE THE R.F. GAIN CONTROL BELOW THE POINT OF BLOCKING OR OVERLOADING; ALSO BE SURE THAT THE CRYSTAL SWITCH IS IN THE "OUT" POSITION AS WELL AS THE A.V.C. SWITCH IN THE "OFF" POSITION.

BE SURE TO CHECK IMAGES - IMAGES WILL FALL A LITTLE LESS THAN 1,000 KC LOWER IN FREQUENCY THAN THE FUNDAMENTAL OR HARMONIC OF THE SIGNAL FROM THE GENERATOR. BECAUSE OF THE TWO RF STAGES IMAGES WILL BE GREATLY ATTENUATED IN COMPARISON TO A UNIT WITH ONE STAGE OF RF.

THE TUNING GANG MUST BE ROCKED WHEN MAKING THESE ADJUSTMENTS.

NOTE#1 HARMONICS OF SUITABLE FREQUENCIES MAY BE USED IF THE FOLLOWING SUGGESTED FREQUENCIES ARE NOT AVAILABLE.

" 2 IT IS NECESSARY TO REPEAT EACH PAIR OF OPERATIONS SEVERAL TIMES UNTIL NO CHANGE IS NOTED.

" 3 GREAT CARE SHOULD BE EXERCISED IN ALIGNING AND ACCURATELY RESONATING EACH CIRCUIT IN THE SPECIAL SUPER SKYRIDER; OTHERWISE YOUR ERRORS WILL BE CUMULATIVE AND THE SET WILL FUNCTION POORLY.

OPR.	BAND	RECEIVER DIAL SETTING	SIGNAL GENERATOR FREQUENCY	ADJUST OSC. WITH	TRIMMERS ADJ. FOR MAX GAIN	ADJUST OSC. WITH	PADDERS ADJ. FOR MAX GAIN
1	1	600kc	600kc	-----	-----	C22	-----
2	1	1400kc	1400kc	CA	Cb Cc Cd	-----	-----
3	2	1800kc	1800kc	-----	-----	C21	-----
4	2	4000kc	4000kc	CE	CF Cg CH	-----	-----
5	3	5000kc	5000kc	-----	-----	C19	C5 C9 C13
6	3	9000kc	9000kc	CI	CJ CK CL	-----	-----
7	4	10,000kc	10,000kc	-----	-----	C20	C6 C10 C14
8	4	18,000kc	18,000kc	CM	CN Co Cp	-----	-----
9	5	20,000kc	10,000kc	-----	-----	C18	C7 C11 C15
10	5	30,000kc	10,000kc	Ce	CR Cs Ct	-----	-----
11	6	40,000kc	20,000kc	-----	-----	C17	C16
12	6	60,000kc	20,000kc	Cu	Cv	-----	-----

SERVICING SUGGESTIONS

TO MAKE A RAPID CHECK OF THE RECEIVER REMOVE THE GRID CAP OF THE 6R7 TUBE AND TOUCH THE CAP OF THE TUBE WITH YOUR FINGER. IF A LOUD HUM IS HEARD THE AUDIO END OF THE RECEIVER IS OK.

DEAD SET. CHECK BIAS OF THE R.F. TUBES. IF THE BIAS IS TOO HIGH CHECK THE R.F. GAIN CONTROL FOR AN OPEN. ADDITIONALLY, CHECK THE PLATE AND SCREEN VOLTAGE OF THE R.F. TUBES (SEE CHART).

NOISY GANG WHEN JARRED - INCREASE THE TENSION ON THE GANG WIPERS.

NOISY COIL ASSEMBLY - LIGHTLY TAP THE TRIMMERS OF THE PARTICULAR BAND IN WHICH NOISE OCCURS. ONCE LOCATED THE TRIMMER SHOULD BE REPLACED.

IF LOW SIGNAL AND HIGH NOISE LEVEL DEVELOPS REPLACE THE 6L7 TUBE.

DEAD BEAT OSCILLATOR - IF 6J7 SHOULD SHORT TO GROUND IT WILL OPEN THE B0 CONTROL. CHECK #1 - "B PLUS" TO B0 COIL FOR A GROUND. CHECK #2 - CHECK THE B0 INJECTION CONTROL FOR AN OPEN CIRCUIT. IN MOST CASES A NEW 6J7 WILL CORRECT A DEAD B0.

VIOLENT OSCILLATION - CHECK ALL 6K7 TUBES.

NOISE SILENCER HUM - PROBABLY CAUSED BY A DEFECTIVE 6H6 WITH BAD CATHODE LEAKAGE - REPLACE WITH NEW 6H6 TUBE.

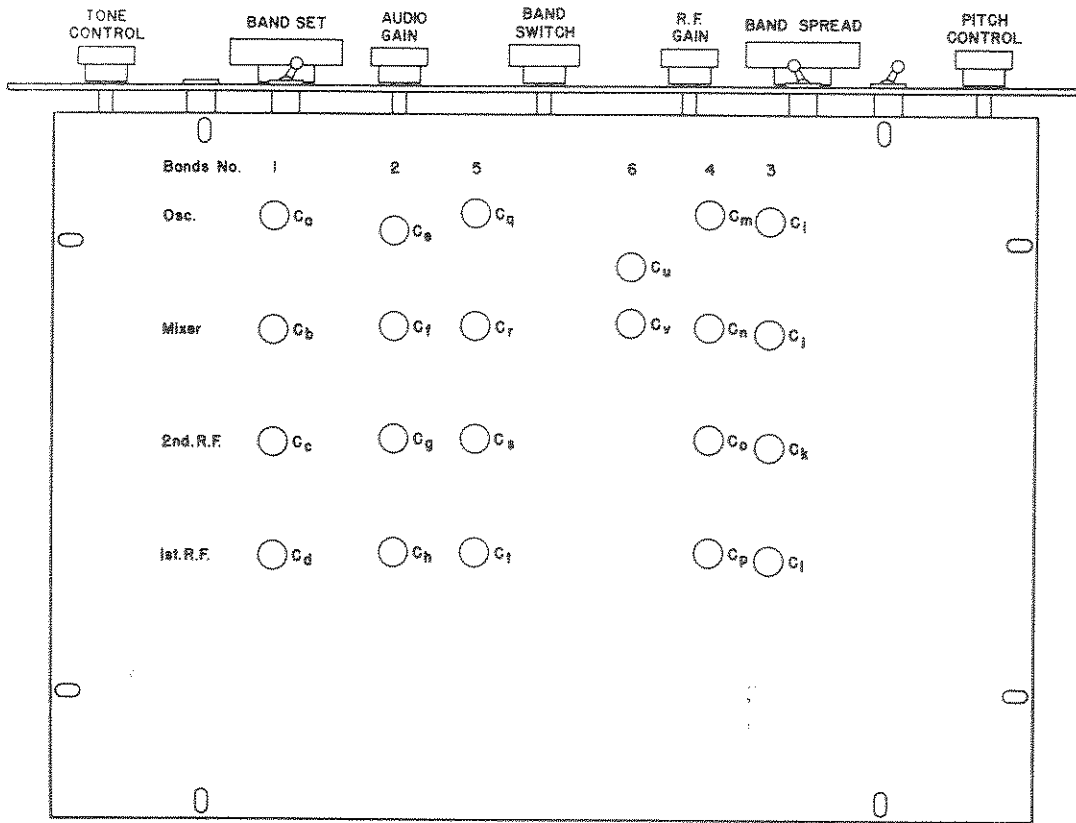
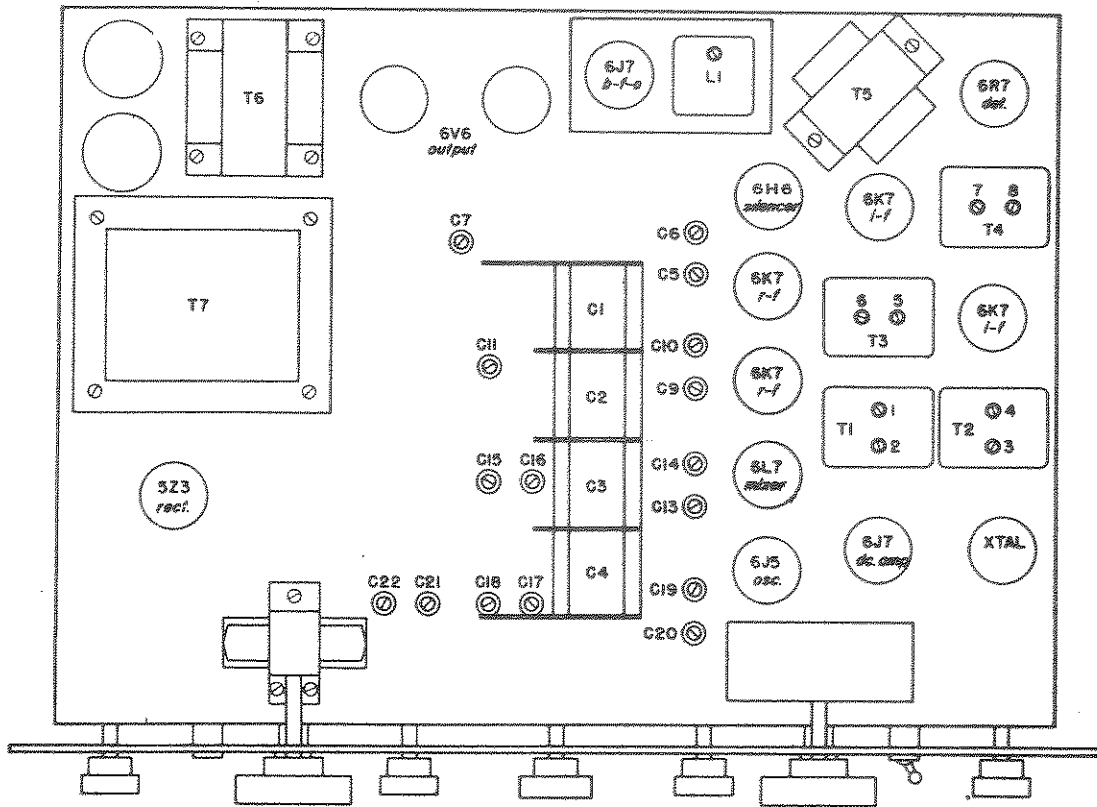

LIST OF CONDENSERS SPECIAL SUPER SKYRIDER MODELS S-17, SX-17

No.	CAPACITY	TYPE	VOLTAGE	No.	CAPACITY	TYPE	VOLTAGE
C1		Main		45	.1 mfd		200
2	420 mmfd	Tunning		46	.002 "	Mica	
3				47	.05 "		400
4		Gang		48	25 "		400
5	100 "	Pad		49	.05 "		400
6	100 "	"		50	.05 "		400
7	310 "	"		51	.002 "	"	
8	880 "	"		52	100 mmfd	"	
9	1,400 "	"		53	50 "	"	
10	590 "	"		54	50 "	"	
11	1,000 "	"		55	10 "	"	
12	350 "	"		56	15 "	"	
13	1,400 "	"		57	15 "	"	
14	590 "	"		58	25 "	"	
15	1,000 "	"		59	25 "	Air	
16	350 "	"		60	.01 mfd		600
17	180 "	"		61	.01 "		600
18	120 "	"		62	10 mmfd	Mica	
19	1,000 "	"		63	250 "	"	
20	350 "	"		64	16 "		400
21	180 "	"		65	16 "		400
22	120 "	"		66	.01 "		600
23	10 "	Mica		67	.002 "	"	
24	10 "	"		68	.002 "	"	
25	.002 mfd	"		69	8 "		450
26	10 mmfd	"		70	.01 "		600
27	10 "	"		71	.0001 "	"	
28	.002 mfd	"		72	.005 "		600
29	10 mmfd	"		73	.0005 "	"	
30	10 "	"		74	.005 "	"	
31	.002 mfd	"		75	10 mmfd	"	
32	.05 "	"	400	76	10 "	"	
33	.05 "	"	600	77	50 "	"	
34	25 mmfd	Air		78	.1 mfd		400
35	.05 mfd		400	79	.1 "		200
36	.1 "		200	80	.1 "		400
37	.05 "		400	81	.002 "	"	
38	.05 "		400	82	10 mmfd	"	
39	.05 "		400	83	10 "	"	
40	.05 "		400	84	.05 "		600
41	.05 "		400	85	10 "	"	
42	.05 "		400	86	.1 mfd		200
43	10.		25	87	.0005 "		450
44	.05 "		400	88	.25 "		400

LIST OF RESISTORS SPECIAL SUPER-SKYRIDER MODELS S-17, SX-17

No.	OHMS	WATTAGE	No.	OHMS	WATTAGE
1	10,000	R.F.Gain	22	100,000	"
2	95	1/3	23	50,000	"
3	10,000	2.5	24	50,000	"
4	10,000	2.5	25	500,000	B.F.O.Control
5	700	1/3	26	100,000	1/3
6	100,000	"	27	500	Meter adj.
7	700	"	28	95	1/2
8	100,000	"	29	400	2
9	30,000	1	30	100,000	1/3
10	100,000	1/3	31	10,000	"
11	10,000	"	32	60,000	"
12	100,000	"	33	1,000,000	Tone Control
13	10,000	"	34	100,000	1/3
14	1,000,000	"	35	10,000	"
15	1,000,000	"	36	100,000	"
16	950	"	37	20,000	"
17	250,000	"	38	2,000	"
18	1,000,000	A.F.Gain	39	1,000	"
19	50,000	1/3	40	10,000	"
20	10,000	1	41	1,500	"
21	100,000	1/3	42	280	1

SWITCHES

- S 1 Selectivity D P D T
- 2 Noise Silencer S P S T
- 3 B.F.O. (Mounted on Control)
- 4 " S " Meter
(Mounted on R.F.Gain Control)
- 5 A.C. off and on
(Mounted on Tone Control)
- 6 Send Receive S P S T
- 7 Crystal S P S T
- 8 A V C S P S T

SCHEMATIC DIAGRAM — SUPER SKYRIDER — TYPE SX-17

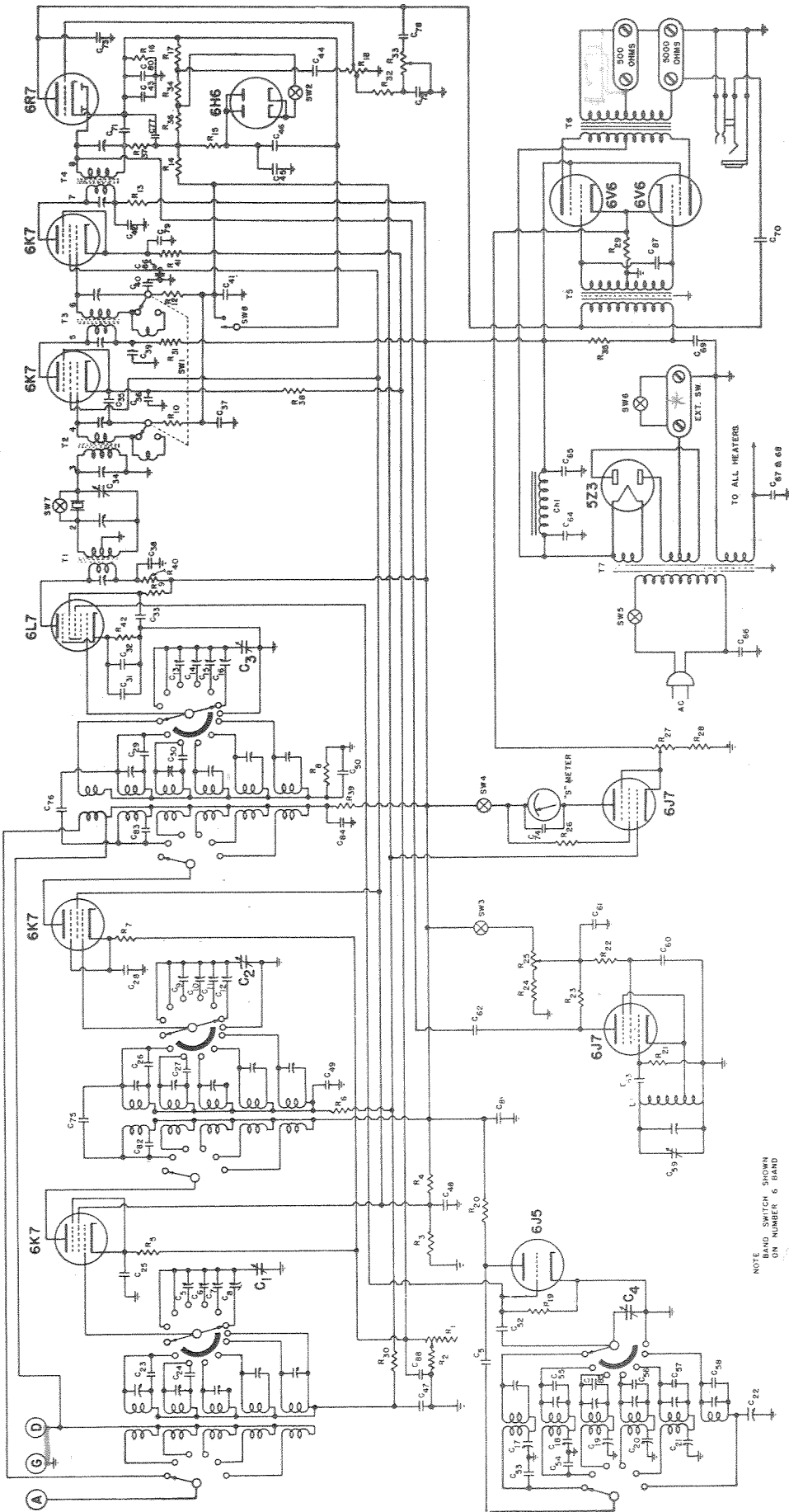

NOTE
BAND SWITCH SHOWN
ON NUMBER 5 BAND

* See ↗

Connections Rear socket

- # 1 - Gnd.
- # 2 - Gnd.
- # 3 - B+ Through 2500 Ω 10w res.
- # 4 - B+
- # 5 - 6.3
- # 6 - 6.3
- # 7 - Pwr Xfmr Centertap } send-receive switch
- # 8 - Gnd.

