



communications

**OPERATING and SERVICE
INSTRUCTIONS**



HT-37



the hallicrafters co.

MANUFACTURERS OF ELECTRONIC EQUIPMENT, CHICAGO 24, U. S. A.



092-104197

Figure 1. Hallicrafters Model HT-37 Transmitter/Exciter

SECTION I GENERAL

1-1. INTRODUCTION

The Hallicrafters Model HT-37 is an 18 tube, self contained Transmitter/Exciter capable of SSB (Single sideband with suppressed carrier), DSB (AM) and CW transmissions in the 80, 40, 20, 15 and 10 meter amateur bands. This unit can represent the complete transmitting complement of any amateur station. The only requirements for immediate "on the air" operation are a 50-ohm terminated antenna system, a key or microphone, and an AC power source.

This unit may be utilized as a complete self-contained transmitter, or as an exciter for a linear power amplifier such as the Hallicrafter Model HT-33A. If other linear amplifiers are employed, they should be capable of supplying a 50-ohm termination to the driver output to utilize the full capabilities of the HT-37.

1-2. T.V.I. (Television Interference) SUPPRESSI

The HT-37 has been designed and constructed to suppress spurious radiations that may cause television interference. The T.V.I. problem was given full consideration in the design of every circuit as well as in the selection and layout of parts. Adequate filtering has been provided for control circuits and AC power

lines. Components were specifically selected to avoid undesired resonances and arranged to prevent parasitic oscillation.

Another important T.V.I. proofing feature is employed in the output coupling circuit of the final amplifier. The tuned output circuit is a pi network that has excellent inherent harmonic suppression ability. The unique design of this network is such that the conventional loading control is unnecessary and only the final tank tuning need be adjusted. The pi network is connected to a coaxial connector and permits the use of any antenna system having a transmission line impedance of 50 ohms. In addition to these factory installed precautions, a commercial 50-ohm low pass T.V.I. filter, which connects between the antenna and the transmitter/exciter output, can be used.

The Model HT-37 Transmitter/Exciter, as received from the factory, has had every advantage of Hallicrafters advanced engineering to minimize television interference. There are, however, some types of T.V.I. that cannot be prevented within the transmitter itself. For example, when a television receiver is located in the immediate vicinity of the transmitter/exciter it is entirely possible that a fundamental signal will reach the input grid of the receiver in sufficient strength to cause a slight amount of interference. In such cases, it will be necessary to install a filter or

trap at the television receiver to attenuate the transmitter's fundamental signal. If the interfering signal does not enter the television receiver through the antenna, special shielding or filters on the TV receiver

may be necessary. For a more complete discussion of measures that may be used to handle these special television interference problems, refer to the ARRL HANDBOOK.

SECTION II

SPECIFICATIONS

TYPES OF EMISSION

SSB Single sideband suppressed carrier, upper or lower sideband

DSB Amplitude modulation

CW Continuous wave

FREQUENCY SELECTION Self contained VFO

FREQUENCY COVERAGE 80, 40, 20, 15 and 10 meter bands

POWER OUTPUT

SSB (PEP) 70-100 watts

CW 70-100 watts

DSB (Carrier) 17- 25 watts

AUDIO INPUT004 V minimum

CARRIER SUPPRESSION 50 db or more below maximum output

UNWANTED SIDEBAND REJECTION .. 40 db or more at 1KC input

DISTORTION PRODUCTS 35 db or more at 1KC input

HUM AND NOISE OUTPUT 40 db or more below maximum output

UNWANTED BEAT OUTPUT ... 55 db or more below maximum output

TUBES 18 including one voltage regulator and two voltage rectifiers

POWER SOURCE ... 105-125 volts, 50/60 cycles AC, 370 watts

RF OUTPUT IMPEDANCE 50Ω. Rear chassis mounted coaxial connector accepts Amphenol 83-1SP connector.

STATION CONTROL Accessory socket. Rear chassis mounted 11 P socket accepts Amphenol 86-PM11 plug (Supplied)

CW KEYING Panel mounted phone jack accepts standard 1/4" plug. Keying point also provided at control outlet.

MICROPHONE INPUT .. Front panel mounted MIKE receptacle (Amphenol 75-PC1M) accepts an amphenol 75-MC1F connector.

DIMENSIONS (Overall) 8 15/16 x 19 7/32 x 15 7/16 (H. W. D.)

SHIPPING WEIGHT 80 lbs.

SECTION III

INSTALLATION

3-1. UNPACKING

After unpacking the HT-37 Transmitter/Exciter, examine it closely for any possible damage which may have occurred during transit. Should any sign of damage be apparent, file a claim immediately with the carrier stating the extent of damage. Carefully check all shipping labels and tags for any special instructions before removing or destroying them.

3-2. LOCATION

The unit should be placed in a location that provides adequate space around it, permitting free circulation of air through the cabinet openings. Avoid excessively warm locations such as those near radia-

tors and heating vents.

3-3. POWER SOURCE

The HT-37 Transmitter/Exciter is designed to operate on 105 to 125 volt, 50-60 cycle AC current. Power consumption is 375 watts.

IMPORTANT: If in doubt about your power source, contact your local power company prior to inserting the power plug into an AC power outlet. Plugging the power cord into the wrong power source can cause extensive damage to the unit, requiring costly

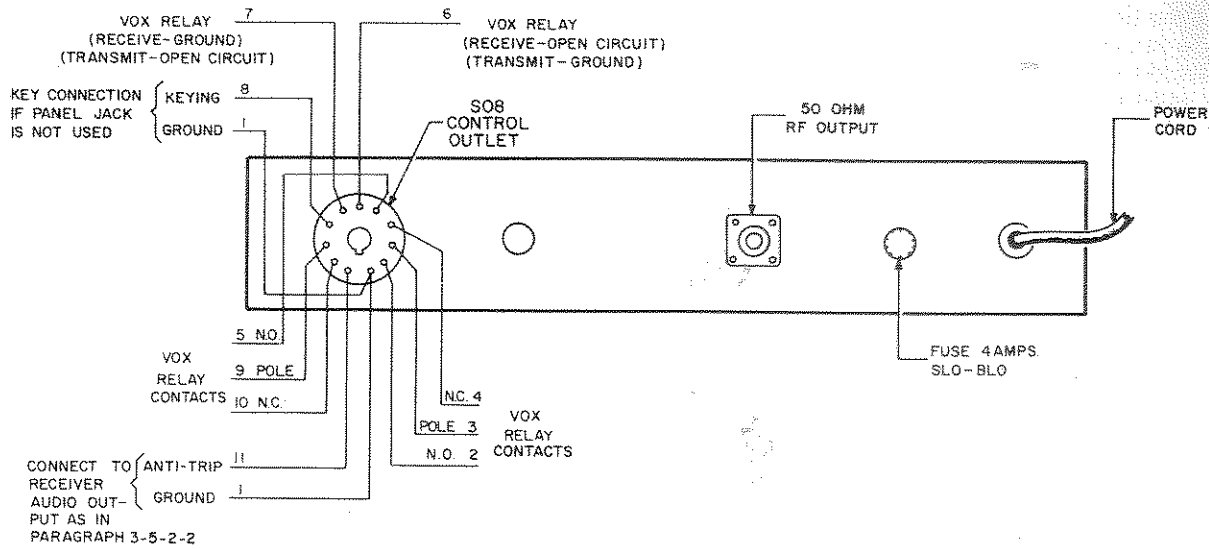

Figure 2. Rear Chassis Connections.

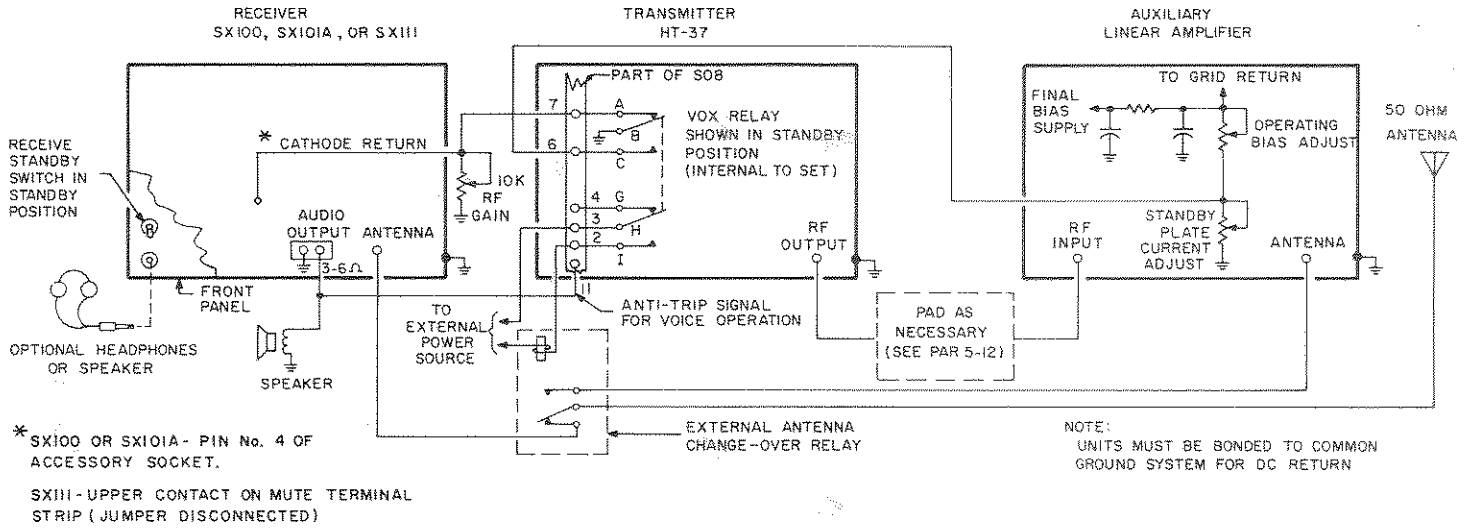

Figure 3. Station Control System See Par. 3-5-2-3 .

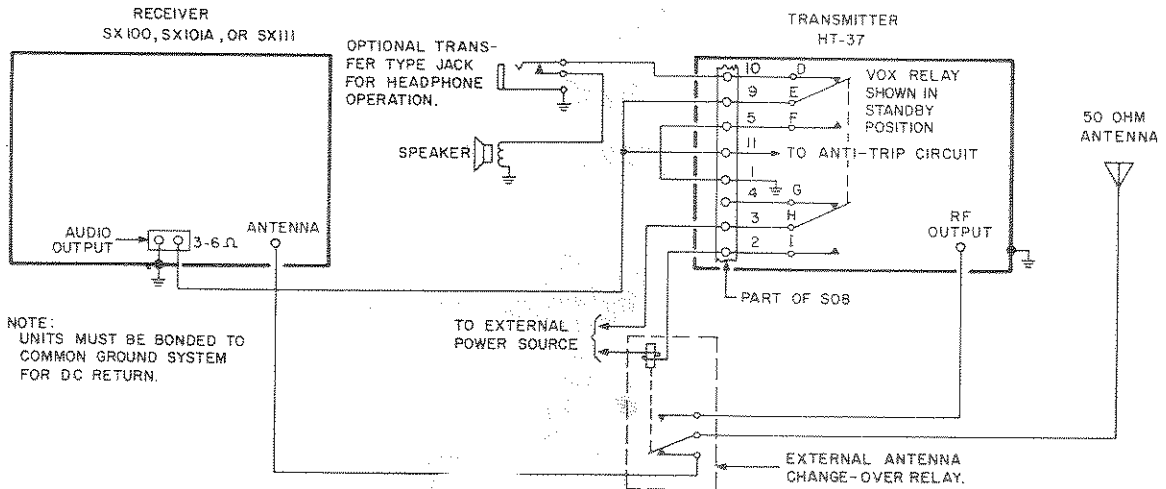

Figure 4. Station Control System See Par. 3-5-2-3.

092-304207

repairs.

3-4. FRONT PANEL CONNECTIONS (See Figs. 1 and 5)

Receptacles are provided on the front panel of the HT-37 Transmitter/Exciter for the following purposes:

3-4-1. MIKE RECEPTACLE

Model HT-37 is designed to operate with a high impedance communications type microphone. The microphone cable should be fitted with an Amphenol type 75-MC1F connector, and should be wired as shown in the schematic diagram, Figure 15.

3-4-2. KEY JACK

This standard two conductor phone jack is provided on the front panel for hand key or "bug" operation. Connections for keying are also provided on the Control Outlet receptacle on the rear panel. See paragraph 3-5-2-1. Wire the plug so that the key base is connected to the sleeve of the plug which is also at chassis ground.

3-5. REAR CHASSIS CONNECTIONS (See Fig. 2)

Sockets are provided on the rear of the HT-37 Transmitter/Exciter for the following purposes:

3-5-1. R.F. OUTPUT

This is a coaxial connector which connects the Transmitter/Exciter to the antenna system or a linear amplifier. The connecting cable (50 ohm coax.) should be fitted with an Amphenol type 83-1SP connector or its equivalent. The selection of the type of antenna and coupling will depend upon the frequencies used and the purpose of operation. Refer to the ARRL ANTENNA HANDBOOK for detailed information concerning transmitting antennas.

3-5-2. CONTROL OUTLET

An eleven pin socket is provided at the rear of the chassis to connect the HT-37 Transmitter/Exciter into the station control system. The mating connector for this socket is an Amphenol 86-PM11.

3-5-2-1. KEY (Pins 8 and 1)

For CW operation the hand key or "bug" is

connected to pins 8 and 1 of the control outlet. Pin 1 is internally grounded to the chassis. When the key is up, cut off bias is maintained at the first and second mixer stages. Closing the key removes the cutoff bias, providing signal excitation to the succeeding RF amplifier stages. A jack is provided on the front panel for those who prefer a panel connection for the key.

3-5-2-2. ANTI-TRIP INPUT (Pins 11 and 1)

The application of the receiver audio output to pins 11 and 1 (ground) prevents "nuisance tripping" when operating the transmitter in the VOX (voice operated transmit) mode with a speaker connected receiver. Any of the normal receiver output impedances may be used for this purpose. See paragraph 5-10 for proper adjustment of the ANTI-TRIP control.

3-5-2-3. ACCESSORY RELAY CONTACTS (Pins 2,3 & 4; 5,9 & 10; and 6 & 7)

Three independent groups of relay switched lines are available at the control outlet. Two groups are switched by standard SPDT contacts, and the other by an SPDT with its pole internally grounded to the chassis. Relay contacts are rated at 1 ampere @ 115V.

Typical applications for these contacts are shown in Figures 3 and 4. These functions or combinations thereof can be modified to suit individual station requirements.

Figure 3 represents a typical control system consisting of a receiver, the HT-37 Transmitter/Exciter, and a linear amplifier. The receiver, in this case, is disabled (during transmission periods) by opening the cathode return lead through the VOX relay contacts. If desired, an auxiliary RF gain control can be connected, as shown, to provide a controllable monitor level during transmission periods. Antenna changeover between the receiver and linear amplifier is accomplished by an external changeover relay (not supplied), actuated by the VOX relay contacts.

Figure 4 represents a typical control system consisting of a receiver and the HT-37 Transmitter/Exciter. During receive periods the speaker is connected to the receiver's output through the VOX relay contacts. At the same time, audio, applied to pin 11 of SO8, supplies the anti-trip signal to the transmitter. When transmitting, the speaker circuit is opened and the audio output is grounded. The antenna is transferred between the receiver and transmitter in the same manner as that in Figure 3.

SECTION IV FUNCTION OF OPERATING CONTROLS

4-1. FUNCTION

The FUNCTION control is a four position rotary switch which selects CW, DSB, UPPER or LOWER SIDEBAND type of transmission as desired by the operator.

4-2. OPERATION

This control is a five position rotary switch which turns the power to the transmitter on or off, places the transmitter in calibrate operation, or selects the mode of operation (VOX or MOX). The "CALIBRATE" position is used in conjunction with the CALIBRATE LEVEL control. (See paragraph 4-10).

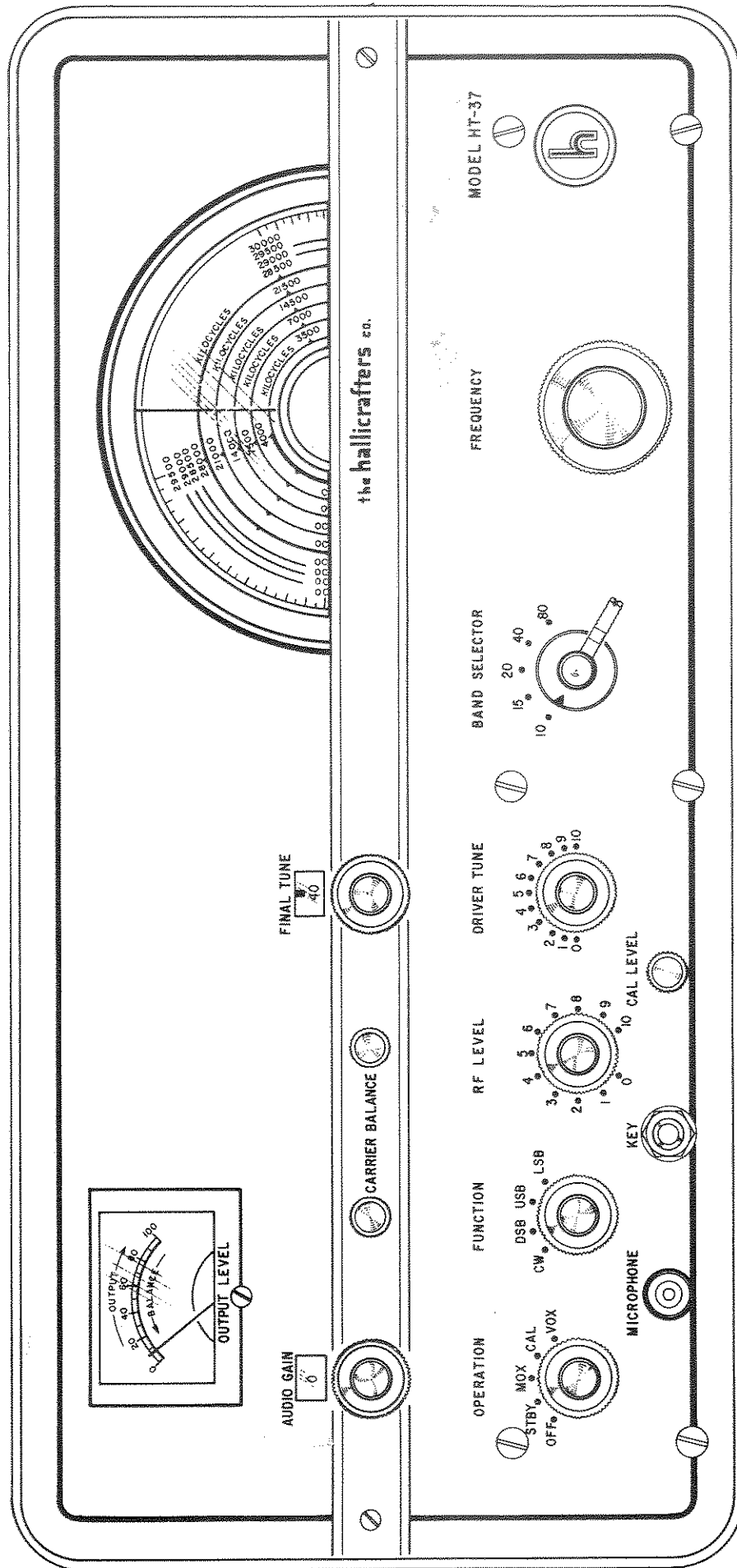

092-304204

Figure 5. Operating Controls

CAUTION

When turning off transmitter, stop momentarily in the "STANDBY" position before turning switch to "OFF" position.

The "MOX" position energizes the transmitter control relay to the transmit position. This position of the OPERATION switch is used when manual control of transmission is desired. Return the switch to the "STANDBY" position during receiving periods.

In the "CALIBRATE" position a controllable low level CW signal is generated for frequency calibration purposes. In this position, control relay (VOX RELAY) operation is inhibited and standby bias is maintained in the transmitter. If an antenna change-over relay is used the receiver will operate normally and the transmitter signal can be monitored and the level to the receiver adjusted with the CALIBRATE LEVEL control. (See paragraph 4-10.)

In the "VOX" position, the transmitter control relay is operated by voice energy from the microphone. The relay tube is biased to cut-off, and will not energize the VOX RELAY until signal excitation is received from the audio amplifier and vox amplifier stages.

4-3. DRIVER TUNING

This control is a variable capacitor in the 2nd mixer plate and driver plate circuits, and will resonate the circuits to any frequency in the 80, 40, 20, 15 and 10 meter bands.

4-4. BAND SELECTOR

The BAND SELECTOR control is a five position rotary switch which selects the proper combination of tuned circuits and stages for the desired frequency band. It also selects the correct audio phase to produce the desired sideband when the FUNCTION switch is set at either "UPPER" or "LOWER SIDEBAND".

4-5. FINAL TUNING

This control is a variable capacitor in the final amplifier tank circuit, and will resonate the circuit to the operating frequency of the selected band. The dial calibrations permit presetting the control roughly during tune up.

4-6. FREQUENCY

The FREQUENCY control is a variable capacitor which sets the VFO frequency. The VFO covers the frequency range 5,000 kilocycles to 5,500 kilocycles. With mixing circuits, the VFO will set the transmitter/exciter to the desired operating frequency as indicated on the dial in any of the five bands.

4-7. CARRIER BALANCE

These controls are connected in the cathode cir-

cuits of the balanced modulator tubes. They provide a means of differentially adjusting the gain of the stages to provide equal outputs resulting in a suppressed carrier signal.

4-8. AUDIO GAIN

This control consists of a potentiometer connected in the grid circuit of the third audio amplifier stage which adjusts the amount of audio drive to the audio modulators. The control has sufficient range to permit adjustment for any high level crystal microphone or low level dynamic microphone normally used for voice communications.

4-9. RF LEVEL

The RF LEVEL control is a potentiometer in the output circuit of the balanced modulators which in CW and DSB adjusts the carrier output of the transmitter. In USB or LSB (suppressed carrier) the control has no effect on output.

4-10. CALIBRATE LEVEL

The CALIBRATE LEVEL control provides a low level adjustment of the transmitter output for SSB, DSB, or CW operation when the OPERATION control is set at CAL. The CALIBRATE LEVEL control is normally set to provide the desired signal level in the station receiver for monitoring purposes and need not be changed except possibly when changing bands. Regardless of the setting of the FUNCTION switch, a carrier signal is obtained for "zero beat" frequency setting. Note that when in the calibrate mode, the RF LEVEL control has no effect on the transmitter output.

4-11. METER SENSITIVITY

The METER SENSITIVITY control is a push-pull switch located on the rear of the CALIBRATE LEVEL control. The full scale sensitivity of the OUTPUT METER is determined by the setting of this switch. Under normal operating conditions, with the switch in the inward position, the meter is calibrated to read approximately 100 volts RMS full scale. During carrier balance adjustments the switch may be placed in the outward position, providing approximately 20 volts RMS full scale deflection.

CAUTION: It should be noted that the high sensitivity position (knob outward) is provided for low level carrier balance adjustments ONLY. Prior to operation of transmitter at full power output, the switch must be placed in the low sensitivity position (inward) or permanent meter damage may result.

SECTION V TUNING PROCEDURE

5-1. GENERAL

The tuning procedure for the Model HT-37 Trans-

mitter/Exciter has been simplified by design as much as possible to permit rapid adjustment by the operator. This does not mean, however, that a transmitter, com-

mercial or home-built, may be operated successfully when only roughly adjusted. A clean signal from any transmitter requires good operator technique.

Two mis-tuning conditions on the HT-37 Transmitter/Exciter are possible, neither of which can be accidentally used on the air. These undesired signals are visible on the output meter due to the extreme range of levels handled by the metering circuit and are 60 db or more below fundamental output when the transmitter is correctly tuned up.

1. On the 15 meter band the undesired signal will appear when the DRIVER TUNE control is set outside its normal tuning range, approximately 0 to 2 divisions on the dial. Note that the signal level cannot be increased with the RF LEVEL control when operating on DSB or CW, nor can it be increased with greater speech input volume on SSB. An improper setting may be recognized through the occurrence of these conditions.
2. On the 10-meter band the undesired signal will appear when the DRIVER TUNE control is set outside its normal tuning range. For example, when tuning the 29 MC to 29.5 MC segment of the 10-meter band, the DRIVER TUNE control will normally tune up around 8 on the dial, while the unwanted signal tunes up at around 4 divisions on the dial. Here again it is identified by the fact that its level cannot be increased on DSB or CW with the RF LEVEL control, nor can it be increased on SSB with greater speech input.

5-2. LOAD

Connect a 50-ohm non-reactive load to the RF OUTPUT connector on the Transmitter/Exciter. This impedance may be an antenna or a properly adjusted linear amplifier. A 50-ohm non-reactive load of at least 100 watts dissipation capabilities is required to handle the full power output.

5-3. INITIAL CONTROL SETTINGS

Set the front panel controls to their starting positions as outlined below.

OPERATION.....STANDBY (Power on)
 FUNCTIONDSB
 AUDIO LEVEL 0
 RF LEVEL3-4
 CARRIER BALANCE CENTER OF ROTATION
 CALIBRATE LEVEL 0
 DRIVER TUNING.....CENTER OF ROTATION
 FINAL TUNING.....DESIRED BAND SEGMENT
 BAND SELECTORDESIRED BAND
 FREQUENCY.....DESIRED FREQUENCY

5-4. BASIC TUNE-UP

The following procedure must be performed for all transmitter modes of operation. Details pertaining to various types of emissions will be discussed in later paragraphs.

1. Set the operation switch at MOX, FUNCTION switch at DSB, and the AUDIO GAIN at zero.

2. Tune the driver and final amplifier stages for MAXIMUM meter deflection, using the DRIVER TUNE and FINAL TUNE controls. Advance the RF LEVEL control slightly, if necessary, to obtain reasonable meter readings for tune up.
3. Set FUNCTION switch to USB for carrier balance adjustments.
4. Adjust CARRIER BALANCE controls for MINIMUM meter deflection. Pull CALIBRATE LEVEL knob OUT to provide maximum meter sensitivity during this operation. Continue adjustment of CARRIER BALANCE controls until no further reduction in level can be obtained.

CAUTION: The CALIBRATE LEVEL knob (meter sensitivity switch) should be in the outward position for CARRIER BALANCE ADJUSTMENTS ONLY. Before proceeding return the CALIBRATE LEVEL knob (meter sensitivity switch) to the IN position. Unless this is observed, permanent meter damage may result.

5-5. CW OPERATION

1. Perform BASIC TUNE-UP procedure, 5-4.
2. Set FUNCTION switch to CW and close key.
3. Advance the RF LEVEL control slowly while observing the output meter. Set the control at a point where further rotation does not cause an appreciable increase in the meter reading. This is saturation output; operate slightly below this level.
4. Recheck the driver and final tuning by reducing the output level by about 5 or 10 on the output meter with the RF LEVEL control. Touch up the DRIVER TUNE and FINAL TUNE controls for maximum meter deflection. Reset the RF LEVEL control for maximum output just below the saturation point, as outlined above.
5. Open the key. The output should drop to zero.
6. The OPERATION switch may be left in the MOX position when operating CW with separate transmitting and receiving antennas, since the transmitter is completely disabled when the key is open. If the transmitter and receiver share the same antenna, and the antenna change-over relay is operated by the relay in the transmitter, the OPERATION switch must be set to STANDBY or CAL to place the receiver in operation.

5-6. DSB (AM) OPERATION

1. Perform BASIC TUNE-UP procedure, 5-4.
2. Set FUNCTION switch to DSB.
3. Advance the RF LEVEL control while ob-

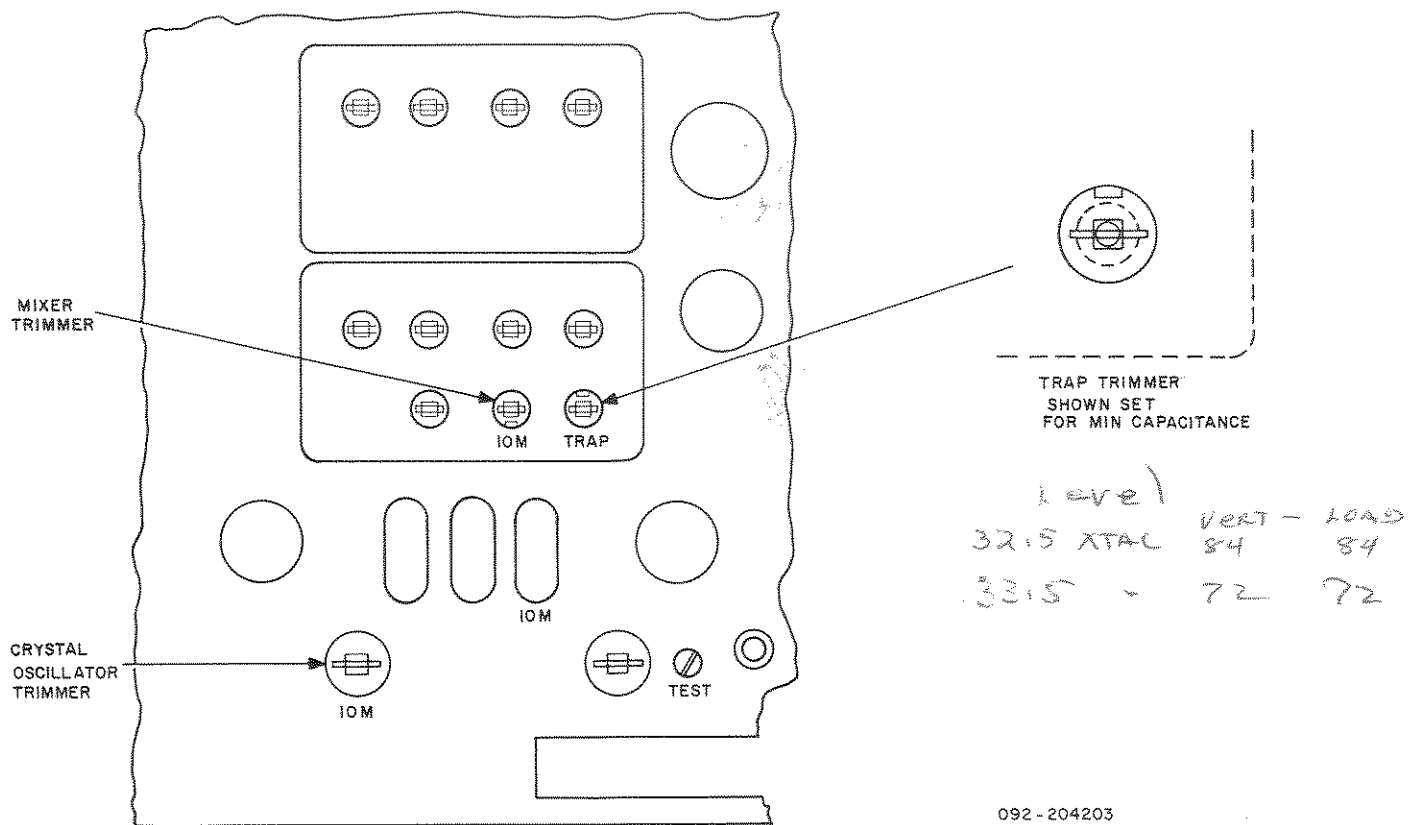

Figure 6. 10 Meter Band Adjustments

serving the output meter. Note saturation level (meter reading at which further rotation of the RF LEVEL control has little effect on the transmitter output). Set RF LEVEL control to half of this reading. This sets the maximum carrier level that the HT-37 Transmitter/Exciter can handle and still provide 100% modulation capabilities.

4. Set the AUDIO GAIN control to the required level providing the desired percentage of modulation.

NOTE: 95 to 100% modulation is evidenced by a very slight increase in meter reading on voice peaks (barely perceptible movement).

5. If manual operation is desired on DSB, switch the OPERATION control between MOX and STANDBY. For voice control operation with the receiver and transmitter interconnected, set the OPERATION control at VOX.

5-7. SSB OPERATION

1. Perform BASIC TUNE-UP procedure, 5-4.
2. Set FUNCTION switch to upper (USB) or lower sideband (LSB) as desired. Note that in SSB the RF LEVEL control has no effect on output.
3. While monitoring the transmitter output, proceed with SSB transmission, setting the

AUDIO GAIN control for the level which does not produce peak flattening or overload distortion of the output signal. With voice excitation, the output meter should indicate approximately 1/2 of the reading shown at saturation level.

4. If manual operation is desired on SSB, switch the operation control between MOX and STANDBY. For voice control operation, set the OPERATION control to VOX.

5-8. SEGMENT ALIGNMENT FOR 10M BAND

The HT-37 Transmitter/Exciter is set up at the factory to provide transmission in the 28.5 to 29.0 MC segment of the 10M band.

The other 0.5 MC segments of the 10M band are set up as follows: (Refer to Figure 6 for locations of the various adjustments referred to in the following procedure).

1. Tune up on CW and determine the saturation level setting of the RF LEVEL control. Record this setting for future reference in step 5 of this procedure.
2. Remove the 32.5 MC crystal and insert desired crystal.*

BAND	NOMINAL FREQ.	OUTPUT FREQ.	PART NUMBER
10M	*32.0MC	28.0-28.5MC	019-201963
10M	32.5MC	28.5-29.0MC	019-201964
10M	*33.0MC	29.0-29.5MC	019-201965
10M	*33.5MC	29.5-30.0MC	019-201966

*NOTE: These crystals are available but not supplied with the transmitter.

3. Connect electronic voltmeter, or similar high impedance DC voltmeter (0-10V), to crystal oscillator test point, and adjust crystal oscillator trimmer for approximately half of the voltage obtained at the maximum voltage setting of the trimmer. Set the trimmer on the gentle slope side of resonance.
4. Set TRAP TRIMMER for minimum capacity, and adjust 10M mixer trimmer for maximum output. Increase RF LEVEL control setting, if necessary, to pick up an output meter reading as the mixer is tuned to resonance. Back off the RF LEVEL as resonance is obtained with mixer trimmer and DRIVER TUNE control.
5. Touch up FINAL TUNE control. Adjust crystal oscillator trimmer and RF LEVEL control until the saturation output again occurs at the RF LEVEL setting obtained for the previous crystal used. See step 1.
6. Trap adjustment - This adjustment is optional as far as spurious output in the 10M band is concerned, since its level is less than 60 DB below fundamental only when the transmitter is mistuned. To locate the spurious signal, turn the RF LEVEL control to zero or switch to upper or lower sideband position of the operation switch, and tune the DRIVER TUNE and FINAL TUNE for maximum output. Adjust the 10M trap trimmer for minimum output meter reading.
7. Recheck the 10M mixer trimmer setting by again tuning up on the desired frequency and peaking the trimmer, since the trap adjustment will affect the original mixer setting slightly.

5-9. VOX AND DELAY CONTROLS

The VOX and DELAY controls are located on the top of the Transmitter/Exciter chassis as illustrated in Figure 7. Both controls are utilized in conjunction with VOX operation and are adjusted to provide control of the transmitter and station receiver.

1. The VOX control is an audio sensitivity control that sets an audio level which will trip (energize) the VOX RELAY, placing the Transmitter/Exciter "on the air". This control should be adjusted with the microphone at the normal speaking distance from the mouth. Advance the VOX control to a setting slightly above that which will "trip" the VOX RELAY. Excessive sensitivity will produce the undesirable effect of background

noise "tripping" the VOX RELAY and placing the Transmitter/Exciter on the air. Note that the VOX sensitivity control and the AUDIO LEVEL control for the microphone are separate level adjustments, hence for example, backing off the AUDIO LEVEL control will not reduce the VOX sensitivity.

2. The DELAY control is a means of adjustment in the grid circuit of the relay tube which determines the time lag in de-energizing the VOX RELAY when audio excitation is removed from the audio amplifier and VOX amplifier stages. This control should be advanced while speaking into the microphone, and set at a position in which the time lapse between words will not de-energize the VOX RELAY. This adjustment will eliminate the constant keying of the Transmitter/Exciter at the beginning of each spoken word. There is a slight interaction between the VOX and DELAY circuits, consequently, a slight re-adjustment of both controls may be necessary to obtain desired results.

5-10. ANTI-TRIP CONTROL

This control is located on top of the Transmitter/Exciter chassis (Figure 7), and is used in conjunction with VOX operation. When the station receiver is connected for VOX operation (Paragraph 5-9 and Figures 3 and 4), the speaker ANTI-TRIP control is advanced to a setting at which the audio signal picked up by the microphone from the receiver's speaker will not energize the VOX RELAY. Note that an excessive speaker gain setting is capable of disabling the VOX relay completely, hence, for best results, the minimum required gain should be used.

5-11. BIAS ADJUST CONTROL

This control has been factory set for -49V, as measured at the adjacent TEST terminal.

The control is located at the rear of the chassis and slightly to the right of center. (See Figure 7.)

An occasional check with an accurate, high resistance voltmeter (20,000 ohms/volt) will insure maximum tube life, since the 6146 final amplifier tubes are operated close to rated plate dissipation for optimum performance.

To adjust the bias, set the OPERATION switch at MOX, FUNCTION switch at either sideband (zero signal), and adjust for $-49 \pm 1V$ with the voltmeter connected between the test point terminal (-) and chassis (+). Note polarity since this is a bias voltage.

5-12. MODEL HT-37 WITH LINEAR POWER AMPLIFIER

When the Model HT-37 Transmitter/Exciter is used to drive a linear amplifier, swamping or padding between the units may be required for optimum performance.

The degree of swamping or padding will depend upon the driving power required by the linear amplifier.

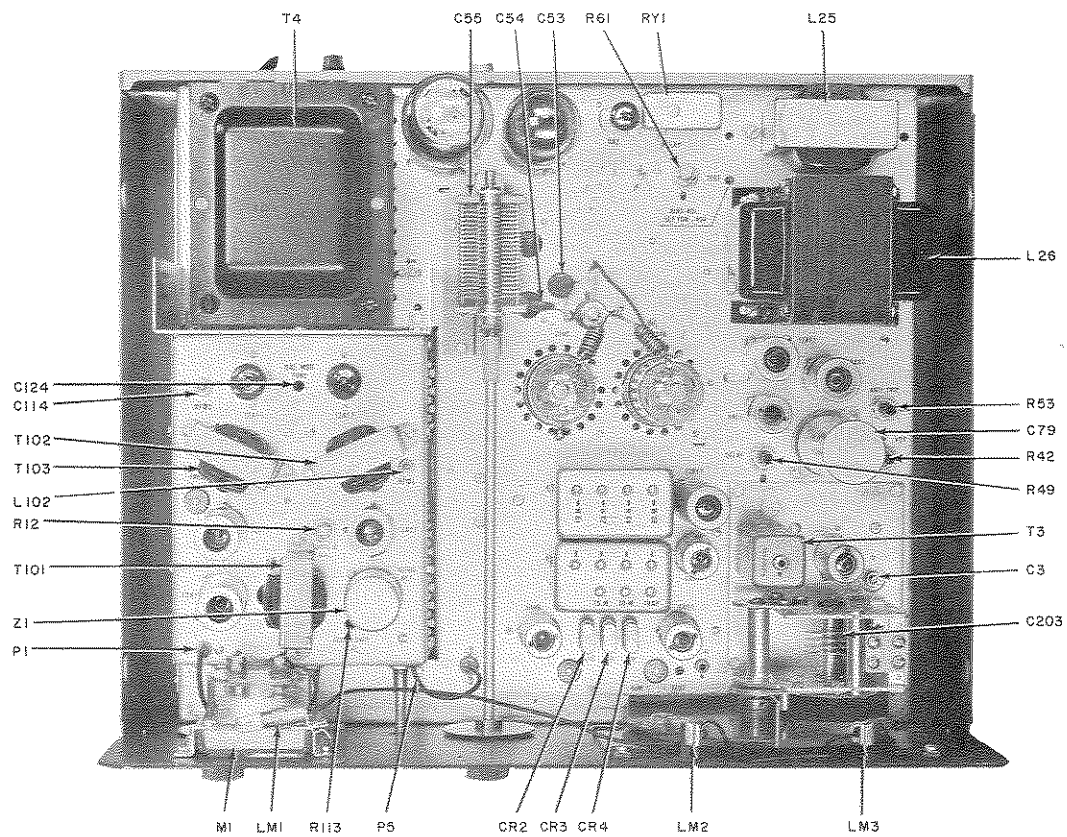

Figure 7. Top Chassis View

092-104198

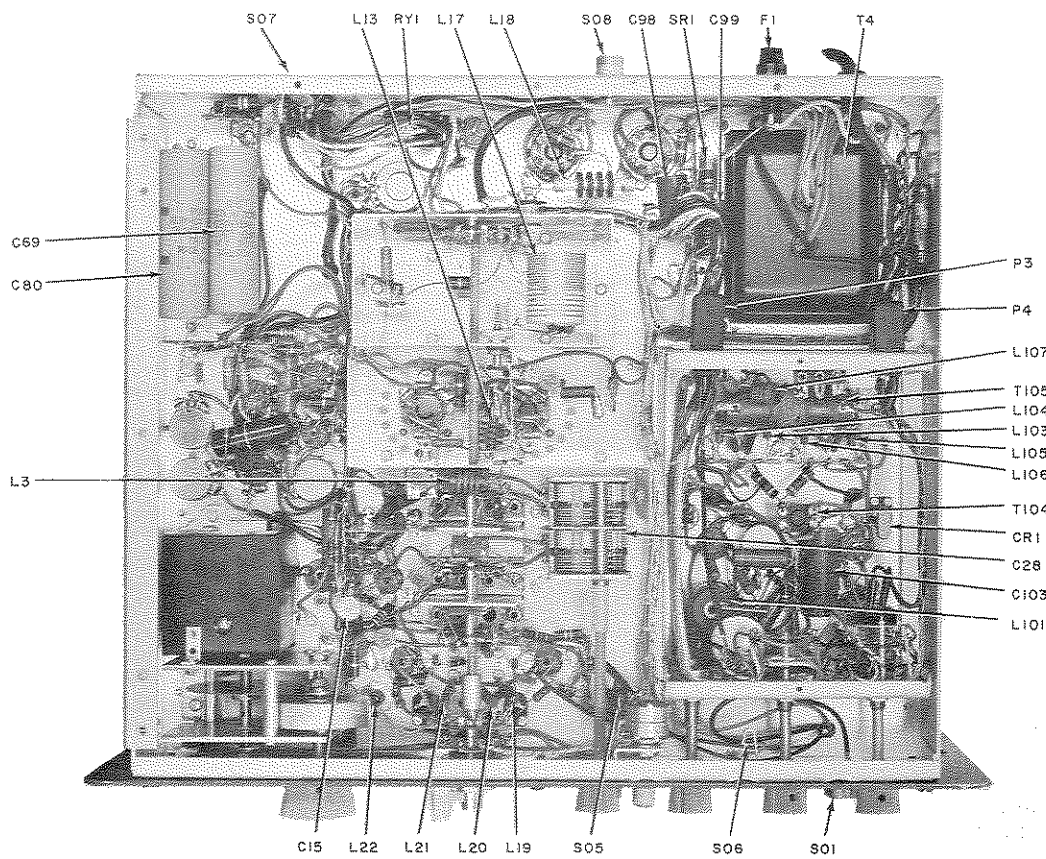

Figure 8. Bottom Chassis View

092-104199

High powered grounded grid or triode amplifiers generally will require little or no swamping, since the driving power will be essentially equal to the power output capabilities of the HT-37. Linear power amplifiers using tetrodes or pentodes, however, generally require considerably less than the peak power output available from the HT-37.

In general, the swamping between units should "soak" up the unused driving power so that the driver unit (HT-37) operates reasonably close to its peak power output and is terminated in a 50-ohm load. This condition will retain the carrier suppression of the HT-37 for the overall system as well as hum and noise ratio which are all related to the peak envelope power output.

For example: Should the linear power amplifier require 40 to 50 watts of drive, then a 3 DB T pad (designed for 50-ohm terminations) would fully load the HT-37, while still transferring the required driving power to the final amplifier grids.

5-13. SERVICE OR OPERATION QUESTIONS

For further information regarding operation or servicing of your Model HT-37 Transmitter/Exciter, write to:

General Service Manager
The Hallicrafters Co.
4401 West Fifth Ave.
Chicago 24, Illinois

Be sure to include the model, serial and date purchased.

Make no service shipments to the factory unless instructed to do so by letter. The Hallicrafters Company will not accept the responsibility for unauthorized shipments.

The Hallicrafters Company reserves the privilege of making revisions in current production of equipment, and assumes no obligation to incorporate these revisions in earlier models.



SECTION VI

THEORY OF OPERATION

6-1. GENERAL DESCRIPTION

The HT-37 Transmitter/Exciter utilizes the phasing principle of generating a single sideband suppressed carrier radiotelephone signal. The circuits are designed so that the sideband signal is generated at a single carrier frequency which is ultimately converted to the desired operating frequency by heterodyne action in the succeeding stages. This permits maximum ease of operation and adjustment of the unit. The circuit also incorporates techniques which permit the generation of continuous wave (CW) and double sideband (AM) type signals.

Figure 12 is a block diagram of the Transmitter/Exciter, and Figure 15 is the schematic diagram.

6-2. SIDEBAND GENERATOR UNIT

The audio section of the sideband generator consists of three stages of conventional audio amplification, followed by a low pass audio filter, C108, C109, and L101, which attenuates those frequencies above 3000 CPS. The audio voltage is fed to the parallel combination of the AUDIO ϕ (Phase) BAL control, R112, and the audio phase shift network, Z1. The AUDIO ϕ BAL control is adjusted so that the outputs of the audio phase shift network are essentially equal, and 90 degrees out of phase with respect to each other. The two

voltages are then independently amplified by the AUDIO MODULATORS, V3A and V3B, and transformer coupled to the grids of the BALANCED MODULATORS, V4 and V5, respectively. The AUDIO BAL control, R113, provides a means of equalizing the relative gains of the audio modulators to produce equal outputs.

Tube V2B is a 9.0 MC crystal controlled oscillator which generates the carrier frequency. The output of the oscillator is fed to a 90 degree RF phase shift network, R118, R119, L102 and C114, where it is split into two equal amplitude components that are 90 degrees out of phase with respect to each other. These two voltages are fed to the input of the BALANCED MODULATORS, V4 and V5.

Tubes V4 and V5 comprise a double balanced modulator circuit consisting of two single balanced modulators with separate input circuits and a common output circuit. Considering the single balanced modulator V4, it is noted that the plates are connected in push-pull through the tank circuit, T105, C123, C124, and C125. The grids are connected in parallel for RF through C115 and C116, and in push-pull for audio through L103 and L104. The CARRIER BALANCE control, R123, permits equalization of gain between V4A and V4B so that with an in phase RF signal at the grids, the resulting output voltages are equal in amplitude and produce essentially zero output at the link of T105.

A push-pull audio frequency applied to the grids through L103 and L104 produces sum and difference frequencies (carrier frequency \pm audio frequency), which, in the output, are 180 degrees out of phase with respect to each other. This produces a net output at the link of two side frequencies, equal in amplitude, displaced by the frequency of the audio signal from the suppressed carrier.

The operation of the other balanced modulator, V5, supplied with input voltages that are 90 degrees out of phase with respect to V4, is such that one of the side frequencies produced is exactly 180 degrees out of phase with the corresponding side frequency of V4, and the other is exactly in phase. Consequently, the in phase components add, the out of phase components cancel, and the net resultant is a single sideband suppressed carrier signal.

Selection of the other sideband is accomplished by reversal of the audio input phase to V4 by means of FUNCTION switch wafer, FS-2R.

A DSB (AM) signal is generated by removing the audio from V4 and introducing a fixed amount of unbalance in V5 through R136 and FS-2F. V4, therefore, remains balanced at the carrier frequency and does not enter into the resultant. V5, however, produces sum and difference frequencies, along with the now present carrier frequency. With no opposite phase components present, the result is a DSB signal with carrier.

CW is similar to DSB operation, with the exception that the audio signal to both balanced modulators is blocked (FS-1F applies -49 volts blocking bias to the grid of the 2nd audio tube, V1B, through R107), resulting in the production of the carrier frequency only.

Depending on the setting of the FUNCTION and OPERATION switches, the signal is transferred from the link of T105 to the main chassis by either the fixed attenuator, R134 and R135 (USB, LSB, and CAL) or the RF LEVEL control, R133, (CW and DSB).

6-3. MAIN CHASSIS

Up to the input stage of the 1st mixer, V7, the operation of the HT-37 Transmitter/Exciter is identical on all bands. The remaining stages "beat" (sum or difference) the 9 MC signal to the desired operating frequency. Frequency multiplication cannot be used, since doubling the frequency would double the spacing of the sidebands. This would change the relative frequency of the modulating frequencies when the signal is detected.

6-3-1. HETERODYNE OSCILLATOR (V6)

The heterodyne oscillator is of the grid-plate type. Bandswitch wafers BS-2R and BS-2F select crystals and components to provide oscillation and output at the required frequencies. The oscillator is operative on the 10, 15 and 40 meter bands only. The plate tank coil, L22, is tuned in conjunction with C65 to provide proper output level on the 15M band. The same coil is used in the tank circuit on 10M and 40M, adjusted for operation with C64 or C66, respectively. The RF output of the oscillator is fed to the grid of the 1st mixer, V7, through C68.

6-3-2. 1ST MIXER (V7)

The 1st mixer operates as a straight through amplifier on the 80 and 20 meter bands, and as a mixer in conjunction with the heterodyne oscillator, V6, on 40, 15 and 10 meters. The operating frequency and gain of the mixer is adjusted for each band by band-switch wafers BS-3F and BS-3R. Plate coil L23 is tuned in conjunction with the fixed capacitor C74 for operation on 40M. The same coil is used on 15 and 10M, tuned with variable capacitors C201 or C78, respectively. On 20 and 80 meters, R16 and/or R38 function as the plate load, tuneable circuits being switched out. On the 10M band, the trap coil, L24, and capacitor C77, are adjusted so that in the mixer plate circuit the crystal frequency generated by the heterodyne oscillator, V6, is attenuated. This prevents subsequent heterodyning of this signal with the VFO, which would produce an undesired output. The 1st mixer output is coupled to the grid of the 2nd mixer, V8, through C16.

6-3-3. VFO (V9)

The VFO produces an RF signal in the range of 5.0 to 5.5 MC, as determined by the setting of the FREQUENCY capacitor, C203. The output of the oscillator is coupled to the grid of the 2nd mixer through the bandpass transformer, T3, and the VFO injection capacitor, C15.

6-3-4. 2ND MIXER (V8)

The 2nd mixer heterodynes the signals from the VFO and 1st mixer to the desired operating frequency. The plate circuit components are selected for each band by switch wafers BS-4R and BS-4F. The output of the 2nd mixer is connected to the grid of the driver stage, V10, through coupling capacitor C30.

6-3-5. KEYING

Bias voltage applied to the grid of the 2nd mixer, V8, through R6 and R7, and to the 1st mixer grid, V7, through R32 effectively cuts off the tubes. Grounding the input of the key click filter, R71, R72, and C204, adjusts the bias of the stages to the operating level. This ground is supplied by one of three methods, depending on the selected mode of operation. In CW the handkey is connected to this point through contacts on the FUNCTION and OPERATION switches. In SSB and DSB, keying is performed by the "J" and "K" contacts of the VOX relay, RY1. In the CALIBRATE mode, an adjustable ground is supplied by the CAL LEVEL control, R73, permitting a controllable low level output.

6-3-6. DRIVER (V10)

The driver stage amplifies the desired signal to a suitable level for operation of the output tubes. Plate circuit components are selected by bandswitch wafers BS-5R and BS-5F. The stage is operated with a fixed level of grid bias supplied through R25. The 2nd mixer, V8, and the driver, V10, are tuned simultaneously to frequency with the DRIVER TUNING capacitor, C28. Output of the stage is coupled to the grids of the final amplifier tubes through C45.

6-3-7. FINAL AMPLIFIERS (V11 and V12)

The output stage consists of two parallel connected 6146 tubes connected to a Pi-section output tank. Bandswitch wafer BS-6 selects portions of L17 and fixed capacitances to provide the proper output impedance on each band. The FINAL TUNE capacitor, C55, is used to tune the tank circuit to resonance.

CAUTION

In all operational conditions other than "Power Off", full plate voltage is present at the top caps of the final amplifier tubes. Safety precautions should be observed to prevent dangerous electrical shock. When changing these tubes, the plate caps should first be shunted to ground discharging any voltage that might be retained by the filter capacitors.

The final amplifiers are bridge neutralized by a neutralization capacitor, C44, in series with C40, in conjunction with the plate tank coil of the driver stage, V10.

6-3-8. VOX AND ANTI-TRIP CIRCUITS

In the VOX mode of operation, when modulating the transmitter with a microphone, a sample of the audio signal at the grid of the 2nd audio tube, V2A, is

supplied to the input of the VOX AMP tube, V13B. The VOX DIODE, V14A, rectifies this signal, causing the RELAY TUBE, V15B, to actuate the VOX relay, RY1, placing the transmitter on the air (See KEYING, 6-3-5). The anti-trip circuit, supplied with a sample of the receiver's output, prevents VOX tripping due to received signals being picked up by the microphone. In this case, the ANTI-TRIP diode, V14B, supplies a "bucking" voltage to the VOX DIODE.

During MOX operation, the bottom end of R51 is grounded, causing conduction of the relay tube, V15B, resulting in relay actuation.

6-3-9. POWER SUPPLY

Three sources of DC voltage are employed in the transmitter. The high voltage rectifier, V17, supplies plate voltage for the final amplifier tubes only. The low voltage rectifier, V18, supplies screen voltage for the final amplifiers and plate and screen voltages for all other tubes. A negative voltage used for grid bias and blocking purposes is supplied by the selenium rectifier, SR1. This source is adjusted with R61 for -49 volts with the FUNCTION switch set at MOX. When the "J" and "K" contacts of the VOX relay open (during receive or standby periods), the loading effect of R46 on the bias bleeder network is removed, resulting in the development of a larger negative bias. This reduces the standby current drain of the final amplifier tubes, resulting in prolonged tube life.

SECTION VII

SERVICE DATA

7-1. CHASSIS REMOVAL

The chassis and front panel assembly are removable from the cabinet. To remove, proceed as follows:

1. Remove four side screws and lift off top cabinet half.
2. Remove 5R4GY rectifier tube and turn entire set over, permitting it to rest on the panel edge and SB generator shield.
3. Remove all screws from the underside of the cabinet, including the rubber feet. Lift off the bottom cabinet half.

7-2. TUBE AND DIAL LAMP REPLACEMENT

Access to the dial lamps and all tubes may be obtained by removing the top cover of the cabinet. See paragraph 7-1.

7-3. TROUBLESHOOTING OF MODEL HT-37

Throughout the design of the Model HT-37 Transmitter/Exciter, full consideration was given to keep maintenance problems at an absolute minimum. In all well designed communications equipments, maintenance and repair problems are generally confined to the checking and replacement of tubes which may become

defective. Malfunctions of this nature are easily isolated and corrected. However, it is entirely possible that a more obscure malfunction may arise. In this event, only thoroughly trained technical personnel should attempt servicing the unit.

A recommended aid for troubleshooting the HT-37 Transmitter/Exciter is a general coverage receiver. This receiver can be used to provide a quick check on various oscillator circuits in the HT-37. A lead connected to the antenna of this general coverage receiver, when placed in the proximity of the oscillator tube in the circuit to be checked, can determine the presence or absence of signal from the stage in question.

NOTE: The frequencies of the various crystals can vary somewhat from the frequencies marked thereon. The frequencies of all the mixer stages can also vary to some degree.

If a malfunction occurs when operating on one particular band and mode of operation, the unit should be checked on all other bands and in all other modes of operation to isolate the difficulty. A careful study of the block diagram in the instruction manual should give a quick clue as to which tubes should be checked. The voltage and resistance charts (Figs. 13 and 14), the schematic diagram (Fig. 15) aid in isolating and correcting a malfunction.

TROUBLE SHOOTING CHART	
SYMPTOM	POSSIBLE CAUSE
No output any band any mode	Power Supply Tubes: V16, V17, V18.
	R. F. Tubes: V2 (Check at 9.0 MC) V4, V5, V7, V8, V9, V10, V11 and V12.
CW Output only, all bands (No DSB or SSB)	Audio Tubes: V1, V2, V3 Balanced Modulators: V4 and V5.
No output, 40 Meters	Heterodyne Osc. V6 Check at 21.5 MC.
No output, 15 Meters	Heterodyne Osc. V6 Check at 25 MC.
No output, 10 Meters	Heterodyne Osc. V6 Check Xtal frequency of portion in use.
Blows Fuses	Check bias voltage at TP2 with output tubes (V11 and V12) removed. Should be -49 ± 1 volt (operation switch in MOX) Measured with a 20,000 ohms/volt D. C. voltmeter.
No VOX operation	VOX Tubes: V13, V14, V15.
VOX will not drop out	Check for hum: V1, V13, V14, V15.

SECTION VIII

HT-37 ALIGNMENT PROCEDURE

8-1. RF ALIGNMENT

Your HT-37 Transmitter/Exciter has been accurately aligned and calibrated at the factory, and, with normal-useage, will not require re-alignment for extended periods of time. Service or replacement of a major component or circuit may require subsequent re-alignment, but under no circumstances should re-alignment be attempted unless the malfunction has been analyzed and definitely traced to RF mis-alignment.

8-2. EQUIPMENT REQUIRED

1. RF Signal Generator; Measurements Corp., Model 65B, or equivalent having a 1V RMS output at an impedance of 70 ohms or less. (A 100 mmf DC blocking capacitor must be placed in series with the RF lead.)
2. Vacuum tube voltmeter (VTVM); Hewlett Packard 410A, or equivalent having an RF probe good to 35 MC.
3. Dummy load; 50-ohms non-inductive, rated at 100 watts. The dummy load may be made up of carbon resistors, Bird Wattmeter, or equivalent.

4. Volt-Ohm-Milliammeter (VOM); Simpson 260 or equivalent.
5. Oscilloscope with external vertical plate connection.
6. Sine wave audio oscillator.
7. Receiver (3-30 MC range), with crystal calibrator.

8-3. INITIAL CONTROL SETTINGS

OPERATION..... STANDBY (Power on)
 FUNCTION DSB
 CAL LEVEL 0
 DRIVER TUNING Fully counterclockwise (Closed gang)
 FINAL TUNING..... ON INDEX (Closed gang)
 FREQUENCY..... Fully counterclockwise (Closed gang)
 BAND SELECTOR..... As instructed
 AUDIO LEVEL 0
 RF LEVEL..... 0

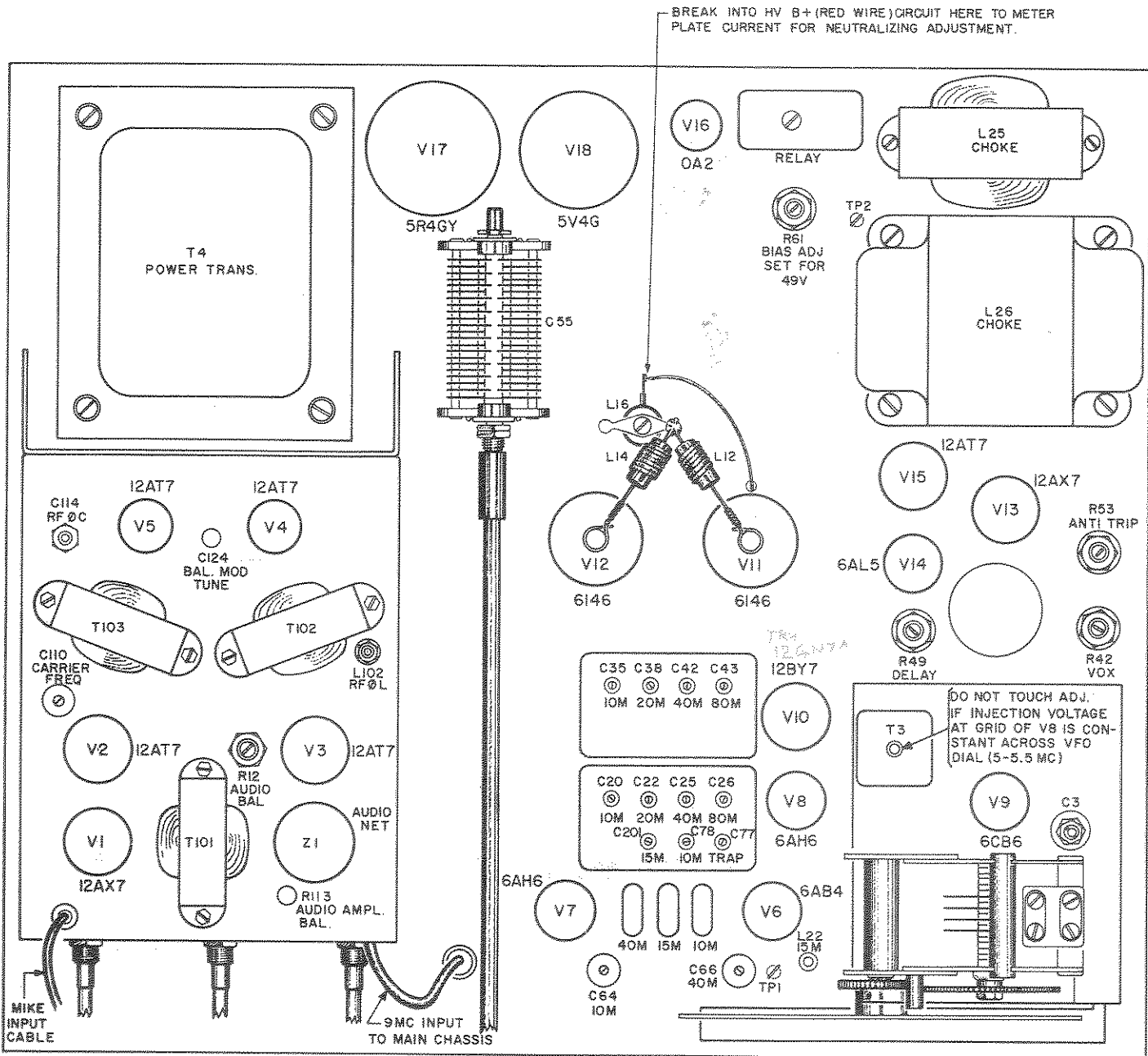

092-404201

Figure 9. Top Chassis Alignment Points

8-4. BIAS ADJUSTMENT

Check the bias voltage before running any extensive checks with the plate and screen voltage applied to the 6146 final amplifier tubes. Set BIAS ADJ. for -49V DC \pm 1V with the OPERATION switch at MOX., and the FUNCTION switch at either "UPPER" or "LOWER" sideband (zero signal). For additional comments on bias adjustment, see paragraph 5-11.

NOTE

Bias adjustment should be made with a high resistance voltmeter (20,000 ohms/volt) only.

8-5. RF ALIGNMENT 1ST AND 2ND MIXER AND DRIVER STAGES

Remove 21.5, 25, and 32.5 MC xtals; Osc. Tube V9; HV Rect V17; and carrier oscillator tube V2.

Disconnect screen lead of V11 (6146, Final Amp) from lug of terminal board on underside of chassis. Set neutralization capacitor, C44, and VFO coupling capacitor, C15, at mid-capacity, if this is to be a complete alignment.

To place the transmitter in operation for alignment, set OPERATION control at MOX. This places operating bias on the 2ND mixer, driver, and output stages.

8-5-1. 2ND MIXER AND DRIVER STAGES

ALIGNMENT CHART									
Step	Band	Signal Generator Connection	VTVM Connection	Trimmer Adjust for Maximum	Coil Adjust for Maximum	Signal Generator Freq. MC		Approx. Driver Tuning Setting	
						f ₁	f ₂	D ₁	D ₂
1	80M	High Side to Pin #1 grid of V8 (6AH6, 2nd Mixer) Common side to chassis. (Generator leads must be kept to absolute minimum to prevent regeneration.)	VTVM to Pin #5 grid of V11 (6146 Final Amp). Common to chassis.	C26 C43	L7 L11	3.5	4.0	2.6	7.4
2	40M	Same as step 1.	Same as step 1.	C25 C42	L6 L10	7.0	7.3	1.8	8.2
3	20M	Same as step 1.	Same as step 1.	C22 C38	L5 L9	14.0	14.35	2.2	7.4
4	15M	Same as step 1.	Same as step 1.		L5 L9	21.0		3.6	
5	10M	Same as step 1.	Same as step 1.	C20 C35	L4 L8	28.0	29.7	2.4	8.0

8-5-1-1. 2ND MIXER AND DRIVER STAGES ALIGNMENT PROCEDURE

1. The 2nd mixer and driver stages alignment procedure for 80, 40, 20, and 10 meter bands is essentially the same, differences being only in frequency used and adjustment location, which can be obtained from the 2ND mixer and driver alignment chart, paragraph 8-5-1. The following is the alignment procedure for 80 meters. Pre-set the Initial Control Settings with the BAND SELECTOR set on the band being aligned (80M).
 - (a) Set trimmers (C26 and C43) to mid-capacity.
 - (b) Pre-set slugs (L7 and L11) to their maximum inductance if they have never been previously aligned.
 - (c) Set the DRIVER TUNING to D₁ (2.6 on Knob).
 - (d) Set the R. F. Generator to f₁ (3.5 MC), using sufficient generator output to obtain a readable indication on the VTVM. If 1V out of the signal generator does not provide a VTVM reading, proceed with slug adjustment below.
 - (e) Carefully adjust each slug (L7 and L11) for maximum deflection on VTVM. Use reference voltage on VTVM of approximately 20V RMS.
 - (f) Adjust the output frequency of the R. F. Generator to f₂ (4.0 MC), using sufficient generator output to obtain about 20V RMS at the grid.
 - (g) Tune DRIVER TUNING for maximum deflection on VTVM. Driver tuning setting should be approximately D₂ (7.4 on the Knob).
 - (h) Adjust trimmers (C26 and C43) for maximum deflection on VTVM.
 - (i) Repeat steps (c) thru (h) until the adjustments result in no appreciable increase in grid voltage. The band is then correctly tracking with maximum output.

2. The 2nd Mixer and Driver Alignment procedure for 15M is slightly different, since the 20M and 15M bands share the same coil. The following is the alignment procedure for 15 meters.
 - (a) Align 20 meter band as outlined above.
 - (b) Set BAND SELECTOR at 15M.
 - (c) Set the R. F. Generator at f₁ (21.0 MC), using sufficient generator output to obtain about 20V RMS at the grid of the final amplifier.
 - (d) Tune DRIVER TUNING for maximum deflection of VTVM. Driver tuning setting should be approximately D₁ (4.2 on the Knob).
 - (e) Adjust slugs (L5 and L9) for maximum deflection of VTVM. If additional gain is obtained with this adjustment, repeat 20 meter trimmer alignment at 14.35 MC and check 14.0 MC for uniform gain on 20M band.
 - (f) Repeat above procedure until no further gain can be obtained on both bands.

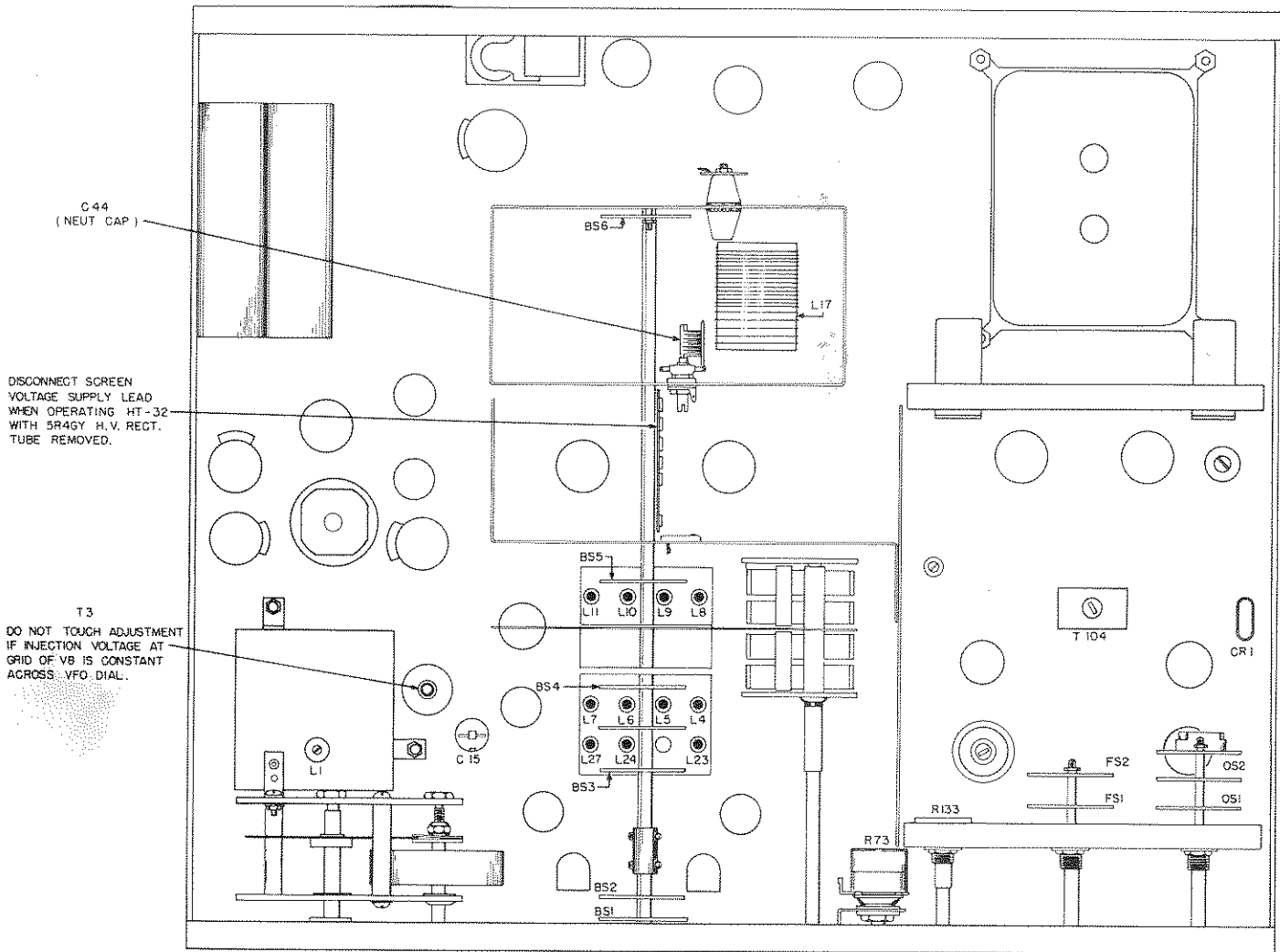

092-304200

Figure 10. Bottom Chassis Alignment Points

8-5-2. 1ST MIXER STAGE

ALIGNMENT CHART								
Step	Band	Signal Generator Connection	VTVM Connection	Trimmer Adjust for Maximum	Slug Adjust for Maximum	Signal Generator Freq. (MC)		VFO Freq. (MC)
						f ₁	f ₂	
1	40M	High side to pin #1 grid of V7 (6AH6, 1st Mixer). common side to chassis.	VTVM to pin #5 grid of V11 (6146, Final Amp.). Common to chassis.		L23	7.2	12.5	7.2
2	15M	Same as step 1.	Same as step 1.	C201		21.0	16.0	21.0
3	10M	Same as step 1.	Same as step 1.	C78		29.0	23.5	29.0

8-5-2-1. 1ST MIXER STAGE ALIGNMENT

The 1st mixer alignment procedure must follow the sequences shown in the chart, since the setting of the coil inductance on 40M must precede the trimmer adjustments on 15M and 10M bands. The following is the alignment procedure for 40 meters.

1. Set BAND SELECTOR at 40M.
2. Set trimmers C201 and C78 at mid-capacity.
3. Set slug (L23) at it's maximum counterclockwise position (minimum inductance).
4. Set Signal generator at f_1 (7.2 MC), with sufficient output to permit setting the driver tuning to resonance.
5. Adjust DRIVER TUNING for maximum deflection on VTVM.
6. Set VFO dial to 7.2 MC.
7. Set R. F. generator at f_2 (12.5 MC). Set generator output for approximately 20V RMS at the final grid while making alignment adjustments.
8. Adjust mixer coil slug L23 for maximum deflection on VTVM.

9. Proceed with the alignment of the 2nd mixer stage on 15M and 10M, using the chart and the above procedures used on 40M.

NOTE

The above alignment for 10M 1st mixer adjustment covers the 28.5 - 29.0 MC 10M segment (32.5 MC xtal) supplied with the HT-37 Transmitter/Exciter. For alignment instructions covering the use of other 10M 0.5 MC segments, refer to SEGMENT ALIGNMENT for 10M BAND in paragraph 5-8.

The 1st mixer plate frequency (f_2) for the various crystals used on the 10M band are as follows:

Trans. freq. range	Xtal freq.	2nd Mixer freq. (f_2)
28.0 - 28.5 MC	32.0 MC	23.0 MC
28.5 - 29.0 MC	32.5 MC	23.5 MC
29.0 - 29.5 MC	33.0 MC	24.0 MC
29.5 - 30.0 MC	33.5 MC	24.5 MC

8-6. HETERODYNE XTAL OSCILLATOR

ALIGNMENT CHART					
Step Step	Band Selector	VTVM Connection	Trimmer Adjustment	Coil Adjustment	Injection Level
1	15M	VTVM to pin #1 of V7 (6AH6, 1st Mixer). Common side to chassis.		L22	0.25V RMS
2	40M	VTVM to pin #1 of V7 (6AH6, 1st Mixer). Common side to chassis.	C66		0.5 V RMS
3	10M	VTVM to pin #1 of V7 (6AH6, 1st Mixer). Common side to chassis.	C64		0.5 V RMS

8-6-1. HETERODYNE XTAL OSCILLATOR ALIGNMENT PROCEDURE

The heterodyne crystal oscillator alignment procedure must follow the sequence shown in the chart, since the setting of the coil inductance on 15M must precede the trimmer adjustments on 40M and 10M bands.

1. Set BAND SELECTOR at 15M.
2. Adjust Xtal Osc coil slug (L22) for 0.25V RMS on the gentle slope side of resonance.
3. Set BAND SELECTOR at 40M.
4. Adjust Xtal Osc trimmer C66 for 0.5V RMS on the gentle slope side of resonance.

5. Set BAND SELECTOR at 10M.
6. Adjust Xtal Osc trimmer C64 for 0.5V RMS on the gentle slope side of resonance.

8-7. VFO CALIBRATION PROCEDURE

The VFO unit has been carefully aligned and temperature compensated at the factory. Before touching up trimmer C3 or coil L1, check the dial calibration at the 100KC points. If all points fall to one side of the pointer, reset the pointer position. If the dial "runs out" across the dial, proceed as follows:

1. Set OPERATION control at STANDBY.

2. Place the antenna lead of the receiver near the VFO unit and set the receiver at 5.0 MC with the xtal calibrator. Receiver BFO turned off.
3. Tune the VFO unit to 4000 KC on 80M.
4. Adjust slug L1 for zero beat.
5. Set the receiver to 5.5 MC with the xtal calibrator.
6. Tune the VFO unit to 3500 KC on 80M.
7. Adjust air trimmer C3 for zero beat.
8. Repeat steps 2, 3, 4, 5, 6, and 7 until calibration is obtained at either end of the dial scale.

8-8. CARRIER OSCILLATOR FREQUENCY AND INJECTION ADJUSTMENTS

Ordinarily the carrier oscillator will not require adjustment in the field. In cases where the carrier oscillator must be set, proceed as follows:

1. Set BANDSWITCH to 80M.
2. Set OPERATION switch to STANDBY.
3. Disconnect shielded cable from sideband unit at main chassis connector (SO5).
4. Place antenna lead of the receiver near the center terminal of the shielded plug, and set the receiver at 9.0 MC with the crystal calibrator. Receiver BFO turned off.
5. Adjust CARRIER FREQ trimmer (C110) for zero beat with receiver crystal calibrator.
6. Connect R. F. probe of VTVM to the output link of T104 at the junction of R118 and R119 on the underside of the SB unit.
7. Adjust crystal oscillator coil slug (T104) for 1.5V RMS on the gentle slope side of resonance.

8-9. BALANCED MODULATOR TANK COIL ADJUSTMENT

The BAL MOD TUNE trimmer (C124) adjusts the resonant frequency of the balanced modulator plate tank circuit to provide maximum SB unit output.

1. Set the OPERATION switch to MOX.
2. Set the FUNCTION switch to DSB.

3. Tune up the transmitter on 80M into a dummy load.
4. Adjust BAL MOD TUNE trimmer (C124) for maximum output level. Reduce the setting of the RF GAIN control if necessary to prevent over-driving the final.

8-10. AUDIO AND RF PHASE SHIFT ADJUSTMENTS

The AUDIO Ø BAL (R112), AUDIO AMP BAL (R113), RFØL (L102) & RFØC (C114) controls determine the degree of suppression of the unwanted sideband. These adjustments are made at one frequency and hold for all other output frequencies of the transmitter. Once properly set, they should require no further adjustment for extended periods of time.

Re-alignment is necessary under the following conditions: replacement of either of the balanced modulator tubes, V4 or V5, or the audio modulator tube, V3; aging of the associated tubes; service or replacement of components in the respective circuits.

A good vacuum tube voltmeter and oscilloscope connected to the transmitter output are an aid in making these adjustments, but are not to be considered as absolutely necessary for alignment.

Satisfactory alignment indication can be obtained by using only an S-meter equipped, communications type receiver. A low level source of 1000 CPS sine wave audio is also required.

For complete understanding of the following alignment procedure, reference should be made to figure 11 of this manual.

1. Tune transmitter as for DSB operation on 80M (3900 KC) into a dummy load.
2. Set OPERATION switch to STANDBY.
3. Set FUNCTION switch to USB.
4. Set AUDIO GAIN control to zero.
5. Allow sufficient time for transmitter to stabilize (approximately 1/2 hour).
6. Set OPERATION switch to MOX.
7. Set CARRIER BALANCE controls for maximum carrier suppression (minimum indication on output meter with the CALIBRATE LEVEL control (meter sensitivity switch) in the OUT position.

IMPORTANT: Carrier balance should be checked periodically during the alignment procedure.

8. Connect source of 1000 CPS sine wave audio to MICROPHONE input socket.
9. With HT-37 AUDIO GAIN control set to 6 on the dial, adjust audio source voltage to produce approximately 2/3 full transmitter output.

NOTE

With audio oscillators that produce a comparatively large output voltage, it may be necessary to insert an attenuator in the audio input lead to prevent overload saturation of the input audio stages.

10. Tune RECEIVER, set to the narrowest selectivity position and with the BFO "OFF", for the maximum S-meter reading at the transmitted sideband frequency (see figure 11A). Adjust antenna coupling and/or receiver RF gain control to prevent receiver saturation while maintaining a good S-meter indication.
11. Set HT-37 FUNCTION switch to LSB. There should be a noticeable reduction in the RECEIVER S-meter reading. As shown in figure 11D, the receiver is now tuned to the "unwanted" sideband frequency.

In cases of extreme mis-alignment of the phase shift controls, RF ϕ L, RF ϕ C, AUDIO ϕ BAL, and AUDIO AMP BAL, it is difficult to locate the "wanted" and "unwanted" sidebands on the basis of signal strength, since the "unwanted" sideband may be equal or even greater in amplitude than the "wanted" sideband. Under these conditions, before proceeding with alignment, it is necessary to determine the sideband relationship to the suppressed carrier. To accomplish this, proceed as follows:

- (a) Set HT-37 FUNCTION switch to CAL.
 - (b) Tune RECEIVER to "zero in" (peak reading on S-meter) on transmitter frequency. Adjust CAL LEVEL control as necessary to provide adequate coupling to receiver.
 - (c) Set HT-37 FUNCTION switch to USB. (Transmitter modulated with 1000 CPS audio tone as previously explained).
 - (d) Tune Receiver, set to narrowest selectivity position to the "wanted" sideband frequency. This will now be the first S-meter peak found by tuning the receiver higher (1KC) in frequency from the carrier setting.
 - (e) Set HT-37 FUNCTION switch to LSB. The receiver is now tuned to the "unwanted" sideband frequency.
12. Starting from the extreme counterclockwise end, adjust AUDIO ϕ BAL control (R112) for maximum S-meter null, i. e. lowest reading.

13. Adjust AUDIO AMP BAL control (R113) for maximum S-meter null.
14. Alternately adjust RF ϕ L (L102) and RF ϕ C (C114) for maximum S-meter null.
15. Readjust AUDIO ϕ BAL and AUDIO AMP BAL controls for maximum null. Only a very slight adjustment should be required.
16. Steps 14 and 15 should be repeated until no further reduction in the S-meter reading can be obtained. Note S-meter reading for future reference.
17. Retune RECEIVER to "wanted" sideband frequency (LSB).
18. Set HT-37 FUNCTION switch to USB. Note S-meter reduction. Compare reading to that obtained on the other sideband.
19. A compromise of the low reading obtained on either sideband should be made by setting the AUDIO ϕ BAL control to "split the difference" between them.

If an oscilloscope is available, this compromise setting can be determined by observing the output waveform as the FUNCTION switch is set alternately between USB and LSB. Proper setting of the AUDIO ϕ BAL control is evidenced by essentially equal ripple appearing on either sideband pattern.

20. Readjust RF ϕ L and RF ϕ C for maximum S-meter null. Note S-meter reading for future reference.
21. Retune RECEIVER to "wanted" sideband (USB) frequency.
22. Set HT-37 FUNCTION switch to LSB. Note S-meter reading.
23. S-meter differences between step 20 and 22 should be compromised as in step 19.
24. Repeat steps 14 to 23 until no further compromise setting is necessary with RF ϕ L and RF ϕ C set for maximum null on either sideband. The oscilloscope representation of this condition will be minimum ripple on either sideband consistent with equal ripple amplitude.

8-11. NEUTRALIZATION OF FINAL AMPLIFIER

Although a signal generator is used here for this adjustment, the carrier on DSB or CW generated by the transmitter on the 10M and 15M bands may be used.

1. Connect signal generator to pin #1 of V7 (1st mixer) through 100 uuf capacitor. Common side to chassis.
2. Connect dummy load to transmitter output.
3. Remove heterodyne oscillator tube (V6) and carrier oscillator tube (V2).

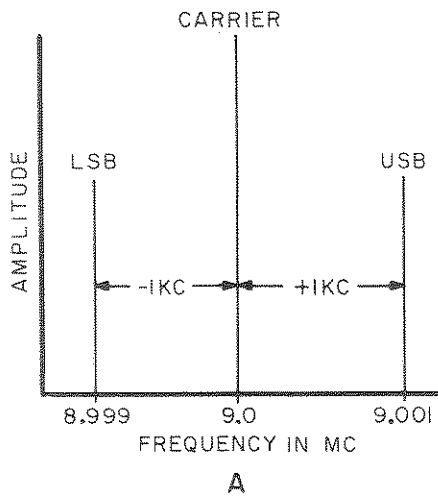

PANORAMIC DISPLAY OF AN AM TYPE SIGNAL. (9.0MC RF CARRIER MODULATED BY A 1000 CPS AUDIO TONE).

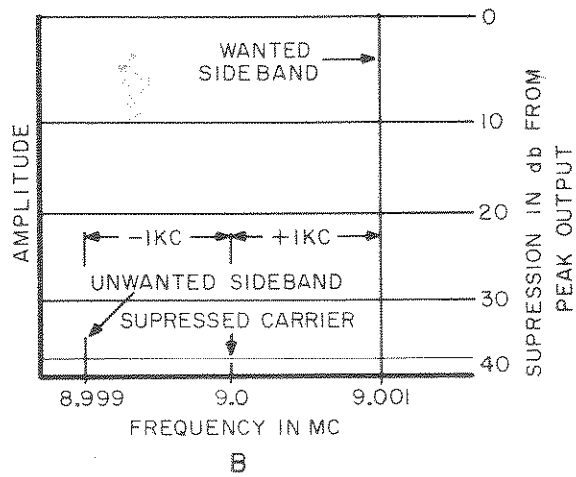

PANORAMIC DISPLAY OF A SSB SIGNAL WHICH WILL PRODUCE A 1000 CPS AUDIO TONE WHEN DETECTED BY A SSB RECEIVER.

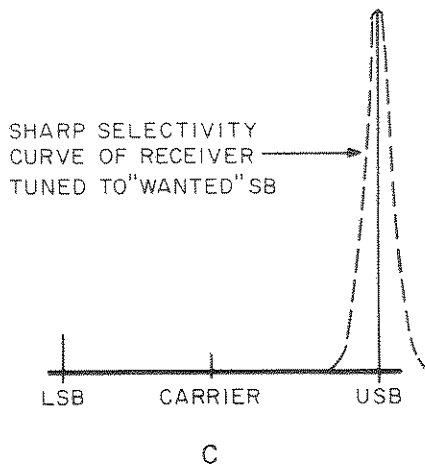

PANORAMIC DISPLAY OF TECHNIQUE INCORPORATED IN CHECKING AND ADJUSTING "UNWANTED" SIDEBAND REJECTION, PARAGRAPH 8-10.

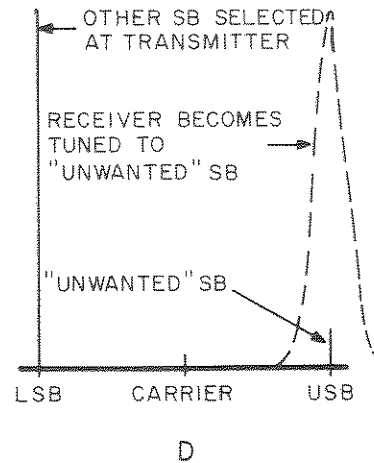

092-104202B

Figure 11. Panoramic Sideband Displays

4. Connect 0-300 MA milliammeter in H. V. plate lead between the filter capacitor (C69) and shunt feed choke (L16).
5. Insert H.V. rectifier and reconnect screen supply lead.
6. Set neutralization capacitor (C44) at mid-capacity.
7. Set OPERATION switch at MOX, and frequency dial at mid position.
8. Set BANDSWITCH at 10M, signal generator at 23 MC, and adjust DRIVER and FINAL TUNING for maximum output. Set signal generator output for 150-175 MA plate current.
9. Tune FINAL TUNE control for plate current dip and observe output meter. Adjust neutralization capacitor until the output meter passes through maximum at the same time the plate current passes through the resonant dip.
10. Set BANDSWITCH at 15M, signal generator at 16 MC, and repeat the above procedure.
11. If the neutralization capacitor setting does not change, the adjustment is complete. If a small change in setting occurs, set the capacitor half way between the two settings and recheck with this compromise setting.

8-12. VFO INJECTION ADJUSTMENT

This adjustment is a coupling trimmer in the output of the VFO unit which governs the amount of VFO injection voltage applied to the 2nd mixer stage.

1. Set BAND SELECTOR at 15M.
2. Set VFO dial to 21.33 MC.
3. Tune the Transmitter/Exciter for DSB operation into 50-ohm load.
4. Remove carrier oscillator tube (V2).
5. Adjust VFO coupling trimmer (C15) for 0.1V RMS RF output across 50 ohms.
6. Connect VTVM probe to pin #1 grid of V8 (6AH6, 2nd Mixer). The injection voltage will be approximately 0.3 to 0.4V RMS. If below 0.3V, check screen and bias voltages on tubes V8 and V10, and check tubes V8 and V10 for malfunction.
7. Replace carrier oscillator tube V2, and tune for maximum saturated power output, which should be at least 60V RMS across 50 ohm load.

8-13. 10 METER TRAP COIL ADJUSTMENT

This adjustment should be made with a 33.5 MC crystal in the 10 meter heterodyne osc. xtal socket. If the 33.5 MC xtal is not available to the operator, the 32.5 MC xtal supplied with the HT-37 may be used to adjust the trap coil. However, when higher frequency xtals are installed, the trap coil must then be reset as outlined below.

1. Preset the trap trimmer (C77) to minimum capacity (slot toward center of RF deck). See Figure 6.
2. Preset the trap coil slug (L24) for minimum inductance (maximum counterclockwise).
3. Tune the transmitter for CW operation on the 10M band.
4. Set the FUNCTION switch at LSB.
5. Adjust DRIVER TUNING and FINAL TUNING for the spurious output. (33.5 MC Xtal-VFO frequency = 28.0 to 28.5 MC.)
6. Adjust trap coil slug (L24) for minimum output.
7. Increase trap trimmer capacity slightly, and reset the trap coil slug for minimum output. Use just enough capacity in the trap trimmer to observe two resonant dips in the spurious output when the trimmer is rotated through minimum capacity.
8. Set FUNCTION switch at DSB.
9. Tune DRIVER TUNING and FINAL TUNING to desired frequency between 29.5 - 29.7 MC.
10. Readjust 10M 1st mixer trimmer (C78) for maximum output with RF LEVEL slightly advanced.
11. Set FUNCTION switch at LSB.
12. Retune DRIVER TUNING and FINAL TUNING for spurious output.
13. Adjust trap coil slug for minimum spurious output and repeat step 10 to be sure the mixer stage is resonant.
14. When crystals other than 33.5 MC are used on the 10M band, it is only necessary to adjust the trap trimmer. The trap coil adjustment is left adjusted for the highest frequency crystal.

8-14. 18 MC TRAP

The 18 MC trap provides additional suppression of a 28,000 KC, 29,000 KC, 30,000 KC and 31,000 KC spurious signal, generated by the 2nd harmonic of the 9 MC sideband generator signal beating with the 2nd harmonic of the 23 to 24.5 MC 2nd mixer output. This spurious signal level becomes objectionable when the transmitter is over-driven on CW or SSB. The trap will help to maintain the 50 DB spurious rejection level, but over-driving the equipment is still to be avoided.

8-14-1. 18 MC TRAP COIL ADJUSTMENT

To check or adjust the 18 MC trap, tune up the transmitter on either 28,000 KC or 29,000 KC in the CW position of the FUNCTION switch (key closed). Leave the RF LEVEL control set for saturated output, and open the key. Remove the VFO tube V9 (6CB6) and then close the key. If the output meter indicates a spurious signal above 2.0 volts, adjust the trap core (L27) for minimum meter reading. At reasonable drive levels, the spurious level will remain 50 DB or more below the maximum fundamental signal power output when the trap is properly adjusted.

SERVICE PARTS LIST

Schematic Symbol	Description	Hallicrafters Part Number	Schematic Symbol	Description	Hallicrafters Part Number	Schematic Symbol	Description	Hallicrafters Part Number
*RESISTORS (SIDE BAND GENERATOR ASSEM.) (cont)			SWITCHES AND WAFERS			TUBES AND RECTIFIERS (cont)		
R117	1K ohm, 1/2W	451-252102	BS1, 2	Switch, Wafer; BAND SELECTOR	060-202076	SRI	Rectifier, Selenium	027-200224
R118, 119	47 ohm	451-352470	BS3	Switch, Wafer; 1st Mixer	062-200102	LAMPS AND FUSES		
R120, 121, 126, 127	15K ohm, 1/2W	451-252153	BS4, 5	Switch, Wafer; 2nd Mixer and Driver	062-200103	LM1	Lamp, Pilot; #47 (Meter)	039-100004
R122, 124, 128, 130	390 ohm	451-352391	BS6	Switch, Wafer; Tank Coil	062-200112	LM2, 3	Lamp, Pilot; #44 (Dial)	039-100003
R123, 129	500 ohm; Variable, CAR-RIER BAL. controls	025-101711	FS	Switch, FUNCTION	060-302058	F1	Fuse, 4 Amp; Sto-Bio, 3AG	039-100448
R132	6.8K ohm, 2W	451-652682	OS	Switch, OPERATION	060-302059	KNOBS		
R133	1K ohm; Variable, RF LEVEL control	025-101712	PLUGS, SOCKETS AND CONNECTORS			Knob, CARRIER BALANCE		
R135	1.5K ohm, 1/2W	451-252152	P1, 5	Plug, Phono	010-100231	Knob, OPERATION, FUNCTION, RF LEVEL and DRIVER TUNE		
R136	180 ohm, 1/2W	451-252181	P2	Line Cord and Power Plug	087-105302	Knob, AUDIO GAIN and FINAL TUNE		
*RESISTORS are 10%, 1W, carbon type, unless otherwise noted.			P3	Plug, 10 Pin	006-100715	Knob, CAL. LEVEL		
TRANSFORMERS AND COILS			P4	Plug, 6 Pin	006-100714	Knob, MAIN TUNING		
L1	Coil Assem., VFO	051-202180	SO1	Connector, Mike	029-100566	Knob, BAND SELECTOR		
L2	Choke, VFO Filament	053-200359	SO2, 5	Jack, Phono	036-100041	CRYSTALS AND DIODES		
L3, 13, 107	Choke, RF (2.5 MH)	053-200335	SO3	Socket, 10 Pin	006-100712	CR1	Crystal, Carrier Osc. (9MC)	019-102299
L4, 8	Coil, RF (10M)	051-202015	SO4	Socket, 6 Pin	006-100713	CR2	Crystal, 21.5 MC	019-201960
L5, 9	Coil, LF (15-20M)	051-202668	SO6	Jack, KEY	036-100064	CR3	Crystal, 25 MC	019-201961
L6, 10	Coil, RF (40M)	051-202017	SO7	Connector, Coax (RF)	010-100056	CR4	Crystal, 32.5 MC (28.5-29.0 MC)	019-201964
L7, 11	Coil, RF (80M)	051-202018	SO8	Socket, 11 Pin	006-200707		Crystal, 32.0 MC (28.0-28.5 MC)	019-201963
L12, 14	Choke, Parasitic Suppressor	053-200417		Socket Assem., Pilot Light	035-100043		Crystal, 33.0 MC (29.0-29.5 MC)	019-201965
L15	Choke, Filament	053-200358		Socket, Tube; Octal (V11, V12, V17, V18)	086-200466		Crystal, 33.5 MC (29.5-29.7 MC)	019-201966
L16	Choke, RF Final Plate	053-200426		Socket, Tube; 7 Pin Min. (V16)	006-100760	CR5	Rectifier, Diode	019-101916
L17	Coil, Final Tank	051-302558		Socket, Crystal (CR2, CR3, CR4)	006-100320	MISCELLANEOUS CHASSIS PARTS		
L18	Choke, RF; Safety	053-100160		Socket, Tube; 7 Pin Min. (V6, V7, V8, V14)	006-200759		Cabinet, Bottom	066-702447
L19, 20	Coil, Xtal Osc. Grid (15 & 40M)	051-202251		Socket, Tube; 7 Pin Min. (V9)	006-100645		Cabinet, Foot	016-100029
L21	Coil, Xtal Osc. Grid (10M)	051-202250		Socket, Tube; 9 Pin W/Base (V1, V2, V3, V10, V13, V15)	006-200672		Cabinet, Top	066-702448
L22	Coil, RF; Xtal Osc. Plate	051-202235		Socket, Tube; Octal (Z1)	006-200296		Clip, Dial Glass Retaining	076-100663
L23	Coil, RF; 1st Mixer Plate	051-202182	V1	ECC83/12AX7; 1st & 2nd Audio	090-901230		Core, Iron	077-100668
L24	Coil, 32-33.5MC Trap	051-202234	V2	12AT7; 3rd Audio and Carrier Osc.	090-900034		Coupler, Insulated	029-100564
L25	Choke, Filter (9HY @ 135MA)	056-300259	V3	12AT7; Modulator	090-900034		Coupler, Solid	029-100264
L26	Choke, Filter (8HY @ 175MA)	056-300260	V4, 5	12AT7; Balanced Modulators	090-900034		Dial, Final Tune	083-300687
L27	Coil, 18MC Trap	051-202656	V6	6AB4; Heterodyne Osc.	090-900784		Dial, Audio Level	083-300688
L101	Choke, Iron Core (50MH)	053-100536	V7, 8	6AH6; 1st & 2nd Mixers	090-900793		Dial, Frequency	083-500691
L102	Coil, RFØL	051-202566	V9	6CB6; VFO	090-901115	M1	Dial Glass, Frequency	022-200602
L103, 104, 105, 106	Choke, RF(500UH)	053-200537	V10	12BY7A; Driver	090-901192		Flywheel	071-000210
T1	Transformer, VFO Band-Pass Filter	050-200679	V11, 12	6146; Final Amplifiers	090-900756		Fuse Holder	006-100845
T2	Transformer, Power	052-400673	V13	12AX7; 1st Anti-Trip Amplifier and VOX Amp.	090-900036		Line Cord Lock (Male)	076-200756-01
T101	Transformer, Audio	055-300397	V14	6AL5; VOX Diode and Anti-Trip Diode	090-901163		Line Cord Lock (Female)	076-200416
T102	Transformer, Audio	055-300398	V15	12AT7; 2nd Anti-Trip Amplifier and Relay Tube	090-900034		Meter, Output Level	082-200416
T103	Transformer, Audio	055-300399	V16	OA2; Voltage Regulator	090-900001		Network, Audio Phase Shift	041-250449
T104	Transformer, Carrier Osc. (9MC)	051-202559	V17	5R4GY; H. V. Rectifier	090-900795		Panel, Front	068-500867
T105	Transformer, Bal. Mod. Tank; Inc. C123 & C125	051-302569	V18	5V4G; L. V. Rectifier	090-900721	RY1	Pointer, Dial	082-200425

SERVICE PARTS LIST (CONT.)

Schematic Symbol	Description	Hallcrafters Part Number	Schematic Symbol	Description	Hallcrafters Part Number	Schematic Symbol	Description	Hallcrafters Part Number
CAPACITORS (MAIN CHASSIS)			CAPACITORS (MAIN CHASSIS) (cont)			*RESISTORS (MAIN CHASSIS) (cont)		
C1, 17, 18, 29, 31, 32, 37, 46, 47, 48, 49, 50, 62, 63, 70, 72, 73, 83, 90, 91, 92, 93, 94, 95, 96, 97	0.005 mfd., 20%; 500V.; Cer. Disc	047-100442	C74	200 mmf., 2%, 500V.; Mica	470-231201	R7, 25	220K ohm, 5%, 1/2W	451-251224
C3	2.6-13.3 mmf.; Trimmer	048-200376	C76	68 mmf., 5%, N220; Cer. Tub.	491-125680-63	R8, 46, 50	47K ohm	451-352473
C4	27 mmf., 5%, N150; Cer. Tub.	491-005270-51	C77, 78, 201	1.5-7 mmf., NPO; 8-50 mmf., N750; Trimmer (3 Section)	044-200474	R9, 19, 31, 38, 39	1K ohm	451-352102
C5, 6	0.001 mfd., 5%, 300V.; Mica	470-100623	C79A, B	60-40 mfd., 475V.; Electrolytic	045-200226	R10, 28	100K ohm, 1/2W	451-252104
C7, 9	0.01 mfd., 10%, 300V.; Mica	470-643103	C81, 82	0.01 mfd.; 1KV.; Cer. Disc	047-200598	R11	39K ohm, 2W	451-652393
C8, 10, 51, 52, 60, 61, 84, 86, 87, 88	0.01 mfd., 500V.; Cer. Disc	047-100224	C85	0.22 mfd., 200V.; Molded Paper	499-014224	R12	12K ohm, 2W	451-652123
C11	6 mmf., 10%, NPO; Cer. Tub.	491-006060-22	C89, 204	0.1 mfd., 200V.; Molded Paper	499-014104	R16	10K ohm, 5%	451-351103
C12, 14	47 mmf. (Part of T1); Not Available Separately	-----	C98, 99	10 mfd., 150V.; Electrolytic	045-200307	R17, 18, 51	100 ohm	451-352101
C13	470 mmf. (Part of T1); Not Available Separately	-----	C203	Variable Capacitor; FREQUENCY	048-300444	R20	6.8K ohm, 5%, 2W	451-651682
C15	1.5-7 mmf.; Trimmer	044-100457	C205	120 mmf., 2%, 500V.; Mica	482-161121	R21	1.2K ohm, 5%	451-351112
C16, 30	47 mmf., 10%, N750; Cer. Tub.	491-106470-95	C206, 207	15 mmf., 2%, 500V.; Mica	482-131150	R22	15K ohm, 5%, 1/2W	451-251153
C19, 75	0.005 mfd., 20%, 1KV.; Cer. Disc	047-100523	CAPACITORS (SIDE BAND GENERATOR ASSEM.)			R27	33 ohm, 1/2W	451-252330
C20, 22, 25, 26, 35, 38, 42, 43	5-25 mmf., NPO; Trimmer (4 Section)	044-200464	C101	0.005 mfd., Cer. Disc	047-100395	R29	10K ohm, 1/2W	451-252103
C21, 36	150 mmf., 2%, 500V.; Mica	482-161151	C102, 129	100 mmf., 10%, N750; Cer. Tub.	491-126101-95	R30	220 ohm	451-352221
C23, 39	82 mmf., 5%, 500V.; Cer. Tub.	491-155820-63	C103	10 mfd., 350V.; Electrolytic	045-200415	R33	270 ohm	451-352271
C24, 41	240 mmf., 2%, 500V.; Mica	470-231241	C104, 107, 128	119, 120, 121, 122, 126, 127, 0.001 mfd., 500V.; Cer. Disc	047-200230	R34	680 ohm	451-352681
C27	47 mmf., 2%, 500V.; Cer. Tub.	491-024470-22	C105	.05 mfd., 500V.; Cer. Disc	047-100624	R35	27K ohm	451-352273
C28A, B, C, D	Variable Capacitor; DRIVER TUNE	048-400453	C106, 111	0.005 mfd., 500V.; Cer. Disc	047-100442	R36, 47, 59	100K ohm	451-352104
C33	33 mmf., 2%, 500V.; Cer. Tub.	491-024330-22	C108, 109	0.01 mfd., 200V.; Molded Paper	499-014104	R40	1.5K ohm, 5%, 10W	453-061152
C34	0.0027 mfd., 20%, 1KV.; Cer. Disc	047-200524	C110	5-25 mmf.; Trimmer, CARRIER FREQUENCY	044-100473	R41	2.5K ohm, 5%, 10W	453-061252
C40	2000 mmf.; Mica Feed-Thru	047-200669	C112	15 mmf., 20%, 500V.; Cer. Tub.	483-011150	R42, 53	1 megohm; Variable, VOX and ANTI-TRIP SENSITIVITY controls	025-201137
C44	2-13 mmf.; Trimmer	048-200316	C113	10 mmf., 500V.; Mica	470-124100	R43, 56	1 megohm, 1/2W	451-252105
C45	100 mmf., 10%, N750; Cer. Tub.	491-126101-95	C114	690 mmf.; RF/OC Trimmer	044-100512	R44, 54, 57	330K ohm	451-352334
C53, 54	0.001 mfd., 3KV.; Cer. Disc	047-100397	C115, 116, 117, 118	100 mmf., 500V.; Mica	470-161101	R45	1.2K ohm	451-352122
C55	Variable Capacitor; FINAL TUNE	048-200445	C123, 125	18 mmf., 2%, (Part of T105)	482-161180	R48	820K ohm	451-352824
C56	380 mmf.; Toothpick	047-100668	C124	5-25 mmf.; Trimmer, BAL. MOD. TUNE (Part of T105)	044-200513	R49	5 megohm; Variable, DELAY control	025-201141
C57	220 mmf.; Toothpick	047-200596	*RESISTORS (MAIN CHASSIS)			R52	1.5K ohm	451-352152
C58, 59	270 mmf., 2%, 500V.; Mica	470-221271	R1, 6, 32	47K ohm, 1/2W	451-252473	R60	1 megohm	451-352105
C64	5-25 mmf.; Trimmer	044-100473	R2, 13, 15	22K ohm	451-352223	R61	10K ohm; Variable, BIAS ADJUST control	025-201412
C65	39 mmf., 2%, NPO; Cer. Tub.	491-124390-22	R3, 55, 58, 64	4.7K ohm	451-352472	R62, 63	18K ohm	451-352183
C66	8-50 mmf., N750; Trimmer	044-200437	R4	1K ohm, 1/2W	451-252102	R67, 68	150K ohm, 2W	451-652154
C67	43 mmf., 5%, N750; Cer. Tub.	491-105430-95	R5	3.9K ohm, 1/2W	451-252392	R70	330 ohm, 1/2W	451-252331
C68	3 mmf., ±0.25 mmf., N750; Cer. Tub.	491-101030-95	*RESISTORS (SIDE BAND GENERATOR ASSEM.)			R71	10K ohm, 5%, 1/2W	451-251103
C69, 80	20 mfd., 600V.; Electrolytic	045-100568	R101, 102	100K ohm, 1/2W	451-252104	R72	4.7K ohm, 5%, 1/2W	451-2511472
C71	68 mmf., 5%, N750; Cer. Tub.	491-125680-95	R103, 108	470K ohm, 1/2W	451-252474	R73	50K ohm; Variable, CAL. LEVEL control (Inc. S1)	025-201718
			R104, 125, 131, 134	470 ohm, 1/2W	451-252471	R74	15K ohm, 1/2W	451-252153
			R105	47K ohm	451-352473	R75	2.2K ohm, 1/2W	451-252222
			R106, 107	1 megohm, 1/2W	451-252105			
			R109	4.7K ohm, 1/2W	451-252472			
			R110	1 megohm; Variable, AUDIO GAIN control	025-101710			
			R111	680 ohm, 1/2W	451-252681			
			R112	500 ohm; Variable; AUDIO PHASE BAL. control	025-101714			
			R113	500 ohm; 4W; Variable, AUDIO BAL. control	025-101713			
			R114, 115	270 ohm	451-352271			
			R116	47K ohm, 1/2W	451-252473			

ADDENDA C-130 1001 disc ADDED 10-20-62 TO PREVENT STRAY RF FROM OPENING VOX.
 C-131 100 DISC

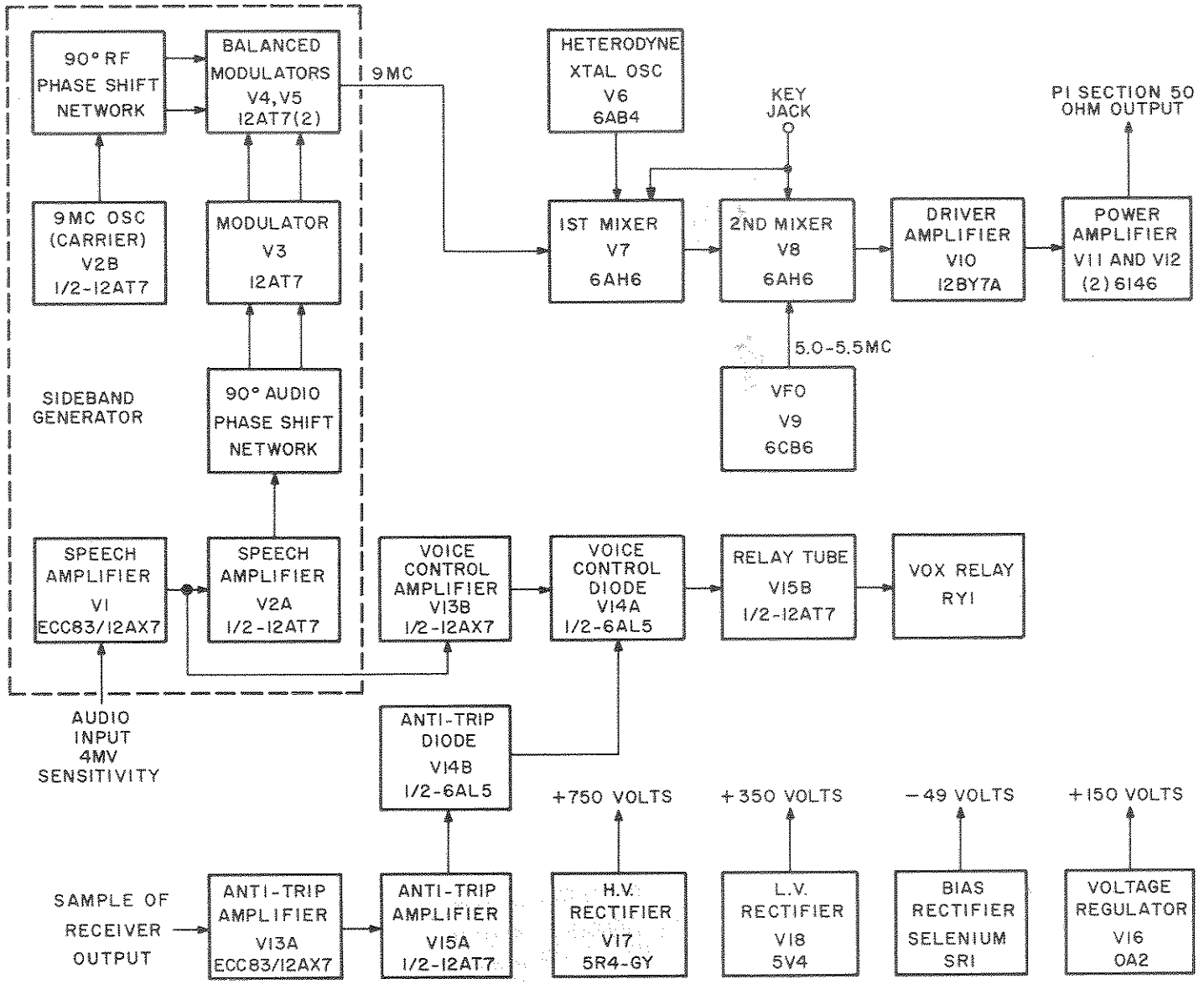

OUTPUT FREQUENCY DEVELOPMENT							
BAND	1ST MIXER, V7			2ND MIXER, V8			BAND
	INPUT		OUTPUT	INPUT		OUTPUT	
	FROM SB GEN.	FROM HET. OSC.		FROM 1ST MIXER	FROM VFO		
80M	9.0MC	INOPERATIVE	9.0MC	9.0MC	5.0-5.5MC	3.5-4.0MC	80M
40M		21.5MC	12.5MC	12.5MC		7.0-7.5MC	40M
20M		INOPERATIVE	9.0MC	9.0MC		14.0-14.5MC	20M
15M		25.0MC	16.0MC	16.0MC		21.0-21.5MC	15M
10M		32.0MC	23.0MC	23.0MC		28.0-28.5MC	10M
10M		32.5MC	23.5MC	23.5MC		28.5-29.0MC	10M
10M		33.0MC	24.0MC	24.0MC		29.0-29.5MC	10M
10M		33.5MC	24.5MC	24.5MC		29.5-30.0MC	10M

092-304205

Figure 12. Model HT-37 Block Diagram.

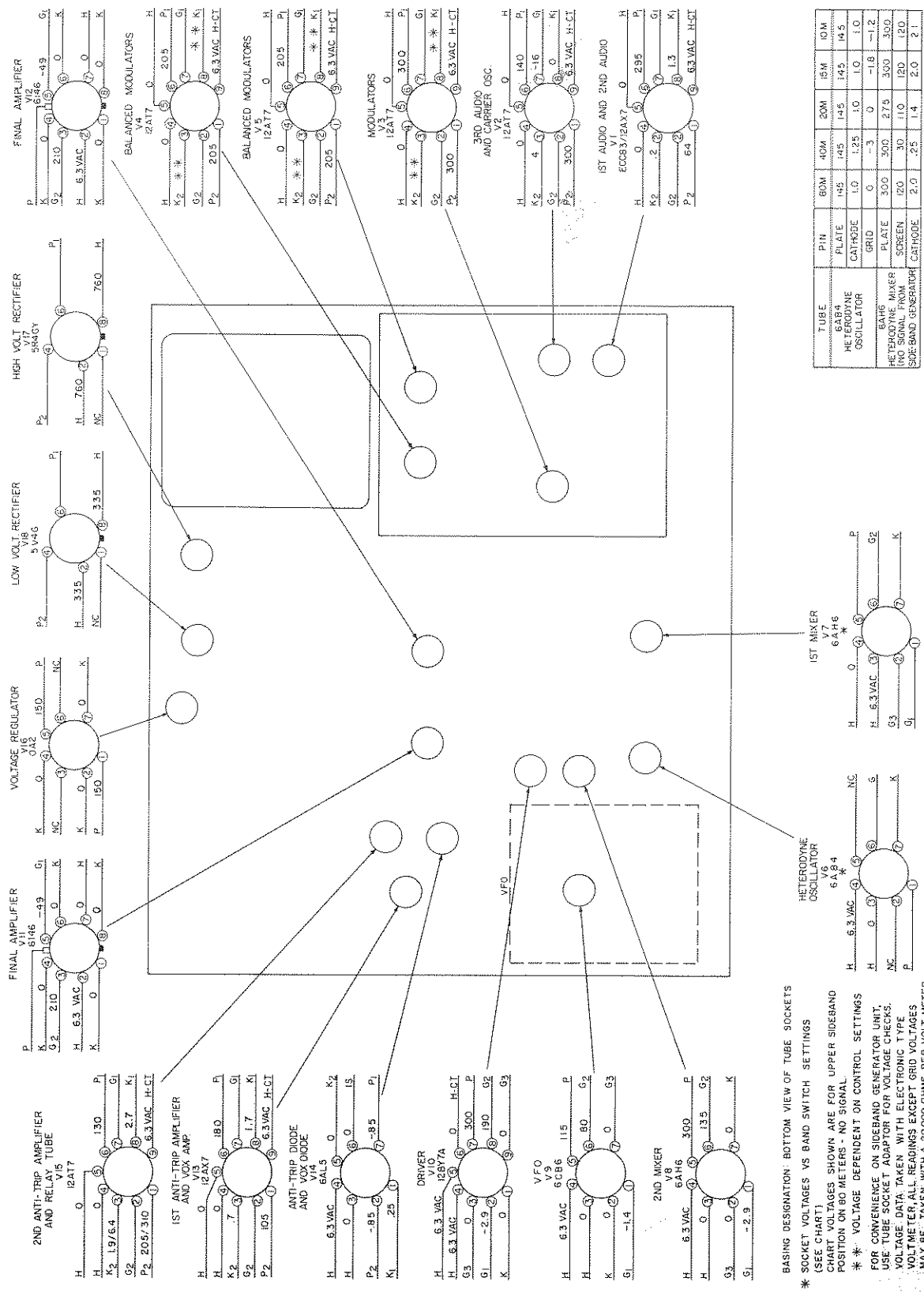

092-504206

Figure 13. Model HT-37 Voltage Chart.

1. BASING DESIGNATION: BOTTOM VIEW OF TUBE SOCKETS
2. * SOCKET VOLTAGES VS BAND SWITCH SETTINGS (SEE CHART)
3. CHART VOLTAGES SHOWN ARE FOR UPPER SIDEBAND POSITION ON 80 METERS - NO SIGNAL
4. ** VOLTAGE DEPENDENT ON CONTROL SETTINGS
5. FOR CONVENIENCE ON SIDEBAND GENERATOR UNIT, USE TUBE SOCKET ADAPTOR FOR VOLTAGE CHECKS. VOLTAGE DATA TAKEN WITH ELECTRONIC TYPE VOLTMETER, ALL READINGS EXCEPT GRID VOLTAGES MAY BE TAKEN WITH A 20000 OHMS PER VOLT METER.

NOTES ON RTTY OPERATION OF THE HT-37 TRANSMITTER/EXCITER

GENERAL

The Model HT-37 Transmitter/Exciter may be frequency shift keyed for teletype operation by diode keying the VFO frequency with a simple adapter. This may be accomplished without disturbing the internal circuitry of the transmitter.

The VFO unit has been provided with a feed-through terminal connected, internally, to the cathode of the 6CB6 VFO tube, V9. This feed-through terminal is located externally as shown on the pictorial. Keying a small capacity to ground at this point will shift the VFO frequency, the frequency shift in cycles being determined by the setting of the small trimmer used for deviation adjustment. The deviation varies with the VFO frequency; however if the deviation is set to 850 CPS at mid-dial, the maximum error at each end of the VFO dial will not exceed 50 CPS. A frequency change of less than 500 CPS is introduced by attaching the keyer unit to the HT-37. The VFO need not be recalibrated unless extreme dial accuracy is desired.

PROCEDURE

The adapter components can be mounted to a five-terminal tie strip which, in turn, can be secured in place by the rear right-hand VFO base-plate mounting screw. When mounting the components, use short, direct, wiring techniques to maintain frequency stability. The bias and keying leads are not frequency sensitive, hence, the length and thickness of these leads are not important. Refer to the schematic diagram for circuit details.

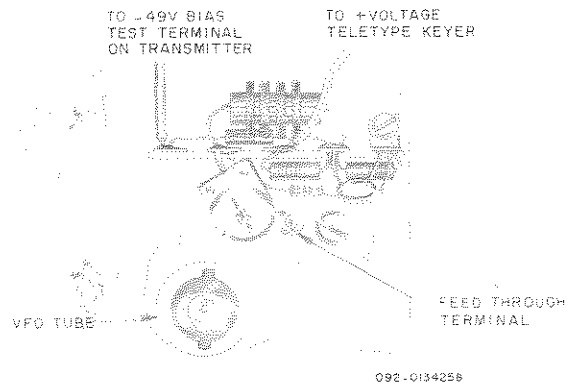

Keyed VFO Adapter.

The adapter may remain connected to the VFO circuit when operating on the normal modes of transmission provided that the teletype keyer unit is so connected electrically as to return the keyer diode to the cut-off condition (negative bias applied to the diode).

To operate RTTY proceed as follows: (1) position the FUNCTION switch at CW; (2) close KEY; (3) position the OPERATION switch at MOX; and (4) tune the transmitter/exciter as for CW operation. Manually operate the teletype keyer circuit to shift the frequency (apply positive bias to the diode) and adjust the adapter trimmer for the 850-CPS shift.

NOTE

Applying positive bias to the diode lowers the VFO frequency which, in turn, shifts the output frequency lower on the 80-meter and 40-meter bands and shifts it higher on the 20-meter, 15-meter, and 10-meter bands.

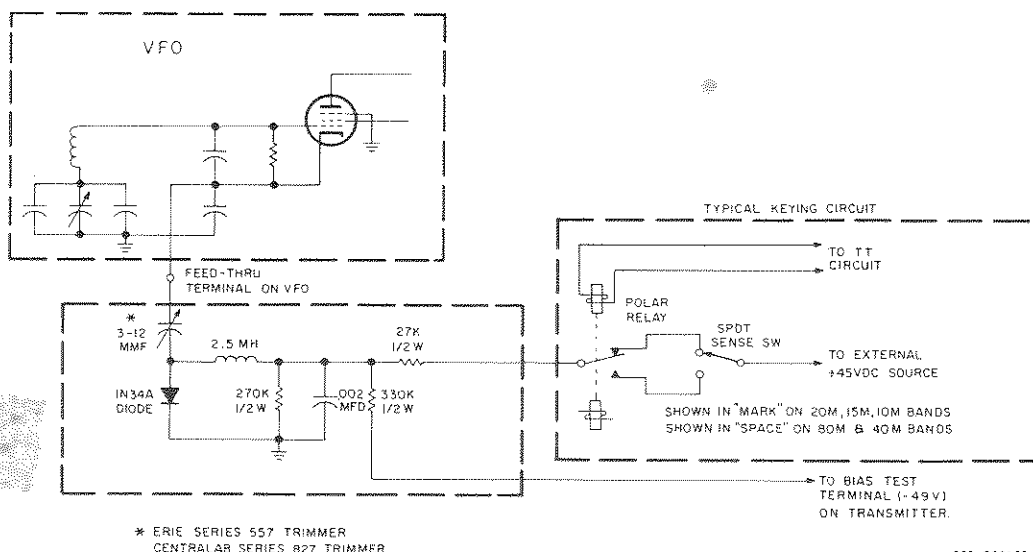

Schematic Diagram of Keyed VFO Adapter.

NOTES

P1 CHANGED - (PUSH TO TALK)

RESISTORS ADDED TO V14A CIRCUIT - BREAK IN CW - CONTROL IS DELAY

S ADDED TO COVER 10M BAND
CR 5, 6, 7 " " " " } 1/15/63

MOX - CW POS BREAK IN AUTO: KEY CLOSES RELAYS

SWITCH ON REAR REMOVES VOX OPERATION.

MAIN CHASSIS

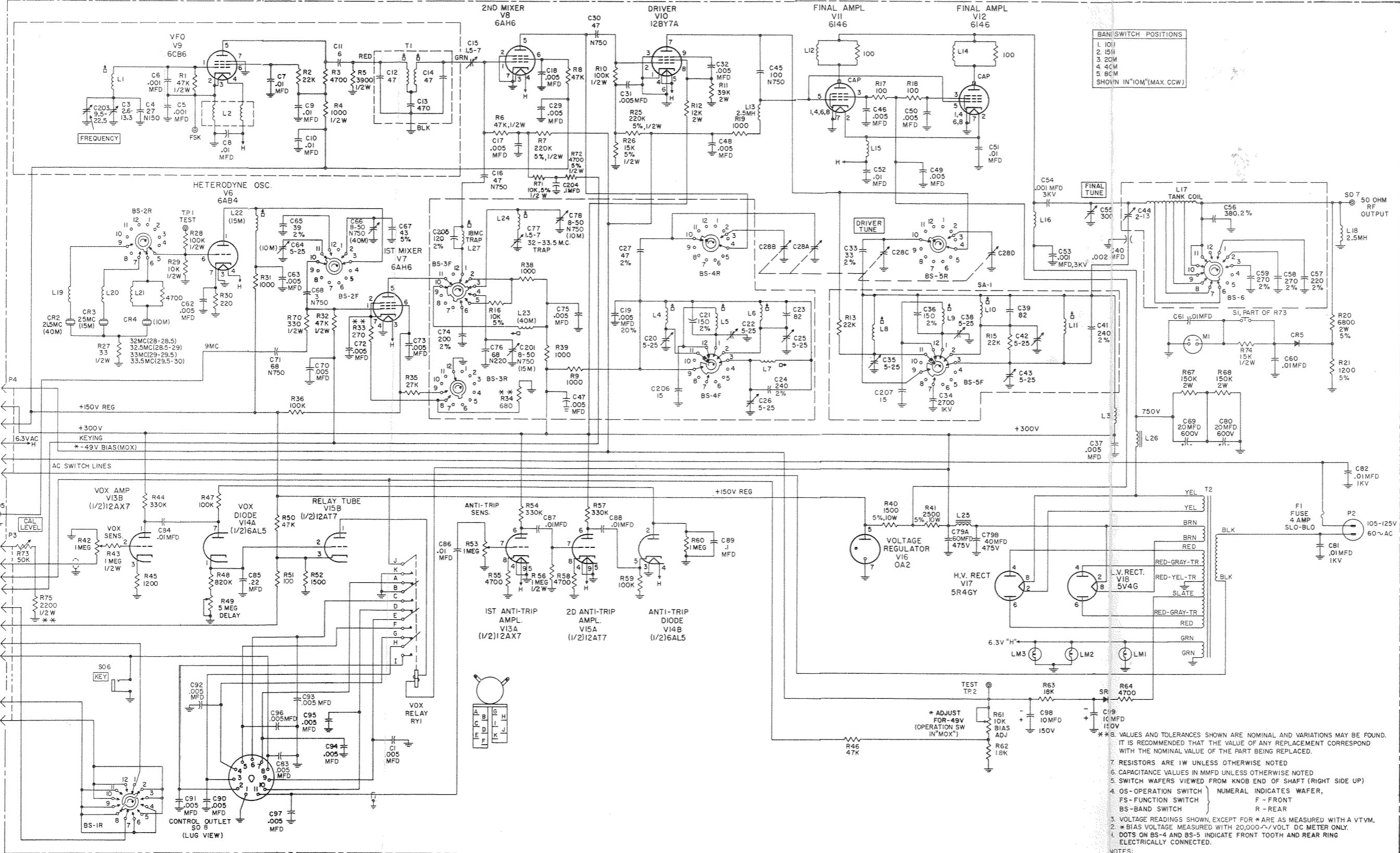

BAND SWITCH POSITIONS

1. 100
2. 150
3. 200
4. 400
5. 600

SHOWN IN "100" (MAX. CCW)

MAIN CHASSIS
LAST RESISTOR — R 75
LAST CAPACITOR — C 207

- IT IS RECOMMENDED THAT THE VALUE OF ANY REPLACEMENT CORRESPOND WITH THE NOMINAL VALUE OF THE PART BEING REPLACED.
1. RESISTORS ARE 1W UNLESS OTHERWISE NOTED
 2. CAPACITANCE VALUES IN MMFD UNLESS OTHERWISE NOTED
 3. SWITCH WAFERS VIEWED FROM KNOB END OF SHAFT (RIGHT SIDE UP)
 4. OS - OPERATION SWITCH NUMERAL INDICATES WAFER, F - FRONT, R - REAR
 5. FS - FUNCTION SWITCH
 6. BS - BAND SWITCH
 7. VOLTAGE READINGS SHOWN, EXCEPT FOR * ARE AS MEASURED WITH A VTVM.
 8. * BIAS VOLTAGE MEASURED WITH 20,000-Ω/VOLT DC METER ONLY.
 9. DOTS ON BS-4 AND BS-5 INDICATE FRONT TOOTH AND REAR RING ELECTRICALLY CONNECTED.
- NOTES:

